

STILETTO COLLECTION

Design
Roberto Paoli

Collection

STILETTO X 80/120

STILETTO Y 80/120

STILETTO APPLIQUE 80/120

STILETTO SHARD 80/120

STILETTO SHARD APPLIQUE 80/120

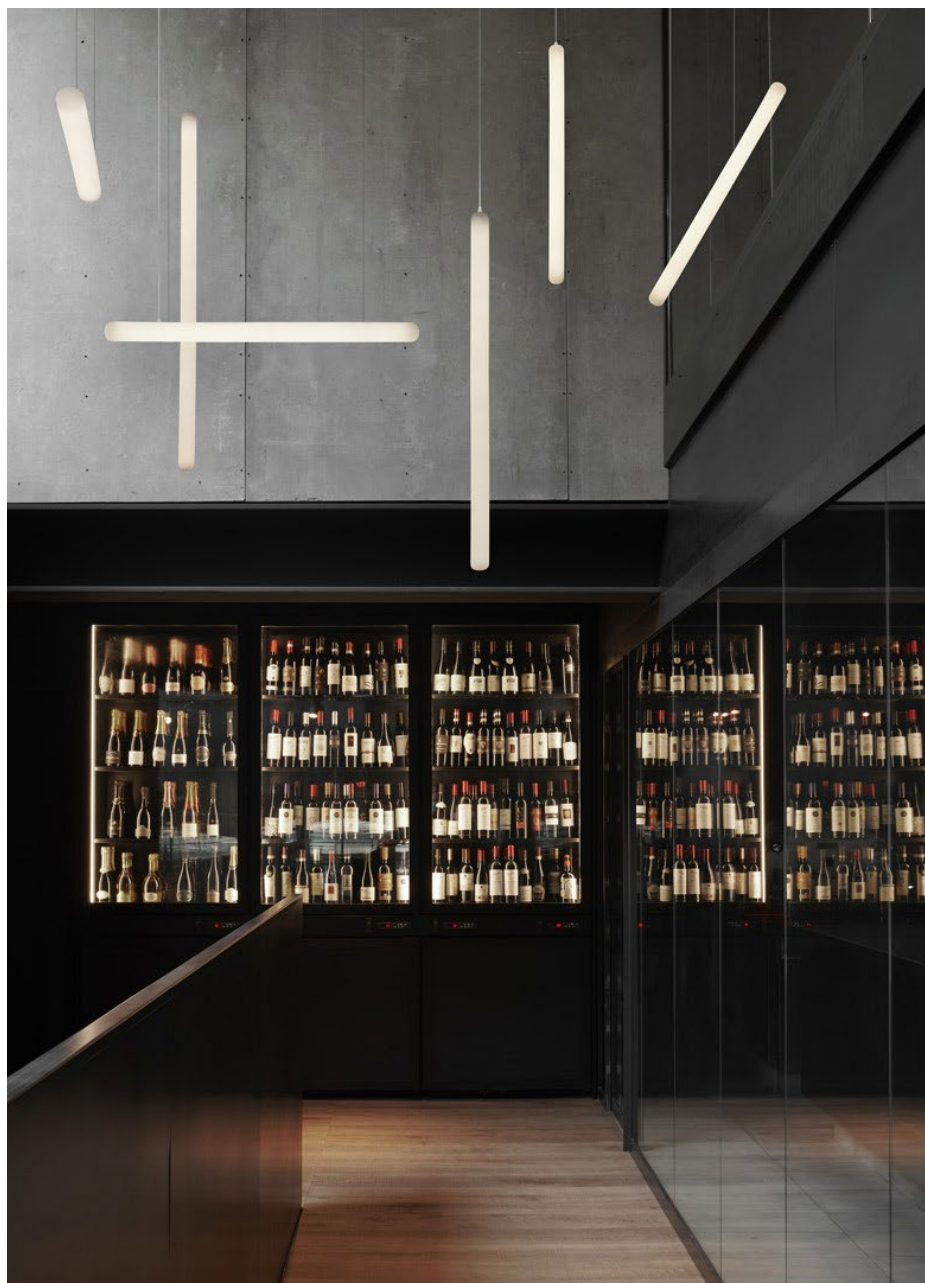

STILETTO X 80

Design
Roberto Paoli

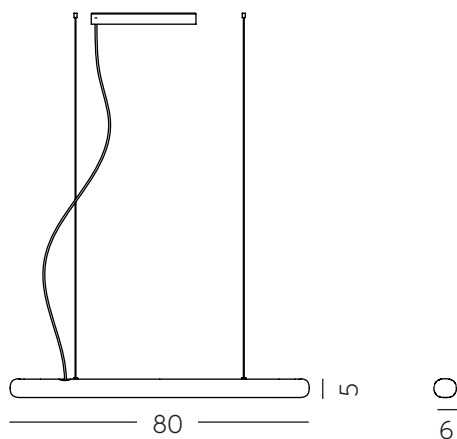







PRODUCT	Category: Categoria: Catégorie:	Hanging lamp Lampada a sospensione Lampe à suspension	PACKAGING	Packaging dimensions: Dimensioni imballaggio: Dimensions emballage:	15 x 15 x 83 cm
	Years of production: Anno di produzione: Année de production:	2020		Packaging volume: Volume Imballaggio: Volume emballage:	0,019 m ³
	Materials: Materiali: Matériaux:	Polyethylene Polietilene Polyéthylène		Total weight: Peso totale: Poids total:	1,6 Kg
	Dimensions: Dimensioni: Dimensions:	80 x 6 h 5 cm		No. of cartons: Nr. di imballi: N° de cartons:	1
	Weight: Peso: Poids:	0,6 Kg		Notes: Note: Notes:	Metal ceiling cap (white matt lacquered). Rosone in metallo (laccato bianco opaco). Patère en métal (laquée blanc opaque).

* Dimensions in centimeters







LIGHTING LED / LED LUMINOSO / LUMINEUSE LED

2700K

CODE CODICE CODE	LP STX082	   		
TECHNICAL INFO INFO TECNICHE INFOS TECHNIQUES	Lithing system: Sistema di illuminazione: Système d'éclairage:	Strip led Strip led Strip led	10W LED system	Included Incluso Inclus
	Wiring: Cablaggio: Câblage:	White cable + driver included Cavo bianco + driver incluso Câble blanc + transformateur inclus		Length: 3 m Lunghezza: 3 m Longueur: 3 m
	Light temperature: Temperatura luce: Température de la lumière:	Extra warm white led light 2700K Luce calda led bianco extra 2700K Lumière chaude LED blanc extra 2700K		
	Accessory on request: Accessorio su richiesta: Accessoire sur demande:	Dimmer Led Kit Dimmer Led Kit Dimmer Led Kit	On request: Su richiesta: Sur demande:	Dali driver
COLOURS COLORI COULEURS	LIGHTING COLOURS			
	 <p>LIGHT WHITE</p>			
	<p>MATT LACQUERED (METAL CEILING CAP)</p>  <p>ABSOLUTE WHITE (white RAL 9016 matching)</p>			
NOTES NOTE NOTES	 <p>metal ceiling cap included with 2 fixing steel cables 280 x 38 h 38 mm</p>			





LIGHTING LED / LED LUMINOSO / LUMINEUSE LED

3000K

CODE CODICE CODE	LP STX080	   		
TECHNICAL INFO INFO TECNICHE INFOS TECHNIQUES	Lithing system: Sistema di illuminazione: Système d'éclairage:	Strip led Strip led Strip led	10W LED system	Included Incluso Inclus
	Wiring: Cablaggio: Câblage:	White cable + driver included Cavo bianco + driver incluso Câble blanc + transformateur inclus		Length: 3 m Lunghezza: 3 m Longueur: 3 m
	Light temperature: Temperatura luce: Température de la lumière:	Warm white led light 3000K Luce calda led bianco 3000K Lumière chaude LED blanc 3000K		
	Accessory on request: Accessorio su richiesta: Accessoire sur demande:	Dimmer Led Kit Dimmer Led Kit Dimmer Led Kit	On request: Su richiesta: Sur demande:	Dali driver
COLOURS COLORI COULEURS	LIGHTING COLOURS			
	 <p>LIGHT WHITE</p>			
	<p>MATT LACQUERED (METAL CEILING CAP)</p>  <p>ABSOLUTE WHITE (white RAL 9016 matching)</p>			
NOTES NOTE NOTES	 <p>metal ceiling cap included with 2 fixing steel cables 280 x 38 h 38 mm</p>			

LIGHTING LED / LED LUMINOSO / LUMINEUSE LED

4000K



CODE CODICE CODE	LP STX081			
TECHNICAL INFO INFO TECNICHE INFOS TECHNIQUES	Lithing system: Sistema di illuminazione: Système d'éclairage:	Strip led Strip led Strip led	10W LED system	Included Incluso Inclus
	Wiring: Cablaggio: Câblage:	White cable + driver included Cavo bianco + driver incluso Câble blanc + transformateur inclus		Length: 3 m Lunghezza: 3 m Longueur: 3 m
	Light temperature: Temperatura luce: Température de la lumière:	Cool white led light 4000K Luce fredda led bianco 4000K Lumière froide LED blanc 4000K		
	Accessory on request: Accessorio su richiesta: Accessoire sur demande:	Dimmer Led Kit Dimmer Led Kit Dimmer Led Kit	On request: Su richiesta: Sur demande:	Dali driver
COLOURS COLORI COULEURS	LIGHTING COLOURS			
	 LIGHT WHITE			
	MATT LACQUERED (METAL CEILING CAP)			
	 ABSOLUTE WHITE (white RAL 9016 matching)			
NOTES NOTE NOTES	 metal ceiling cap included with 2 fixing steel cables 280 x 38 h 38 mm			

COMPONENTS / COMPONENTI / COMPOSANTS

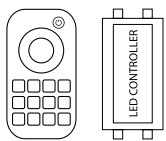
DIMMER LED KIT



Dimming remote control and LED controller

CODE CODICE CODE	LP DIM001 (LED controller)			
TECHNICAL INFO INFO TECNICHE INFOS TECHNIQUES	Dimensions: Dimensioni: Dimensions:	10 x 3 h 2 cm	Weight: Peso: Poids:	0,1 Kg
NOTES NOTE NOTES	LED controller (for nr.1 lamp). Remote control required. LED controller (per nr.1 lampada). Telecomando richiesto. LED controller (pour lampe nr.1). Télécommande requise.			
CODE CODICE CODE	LP DIM002 (remote control)			
TECHNICAL INFO INFO TECNICHE INFOS TECHNIQUES	Dimensions: Dimensioni: Dimensions:	12 x 5 h 2 cm	Weight: Peso: Poids:	0,1 Kg
NOTES NOTE NOTES	RF dimming remote controller, wireless remote 30m distance (for one or more lamps). Telecomando dimmerabile RF, telecomando wireless a 30 m di distanza (per una o più lampade). Télécommande à gradation RF, distance sans fil de 30 m (pour une ou plusieurs lampes). Inserted into the Giotto box if purchased at the same time. Inserito nella scatola Giotto se acquistato contemporaneamente. Inséré dans le carton Giotto si acheté en même temps.			

STILETTO X 120

Design
Roberto Paoli

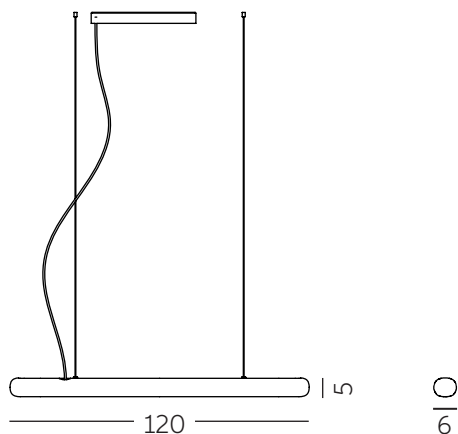





PRODUCT	Category:		Packaging dimensions:	
	Category:	Hanging lamp	Dimensioni imballaggio:	15 x 15 x 123 cm
	Categoria:	Lampada a sospensione	Dimensions emballage:	
	Catégorie:	Lampe à suspension		
	Years of production:	2020	Packaging volume:	0,019 m ³
Anno di produzione:		Volume Imballaggio:		
Année de production:		Volume emballage:		
Materials:	Polyethylene	Total weight:	2,5 Kg	
Materiali:	Polietilene	Peso totale:		
Matériaux:	Polyéthylène	Poids total:		
Dimensions:	120 x 6 h 5 cm	No. of cartons:	1	
Dimensioni:		Nr. di imballi:		
Dimensions:		N°. de cartons:		
Weight:	0,8 Kg	Notes:	Metal ceiling cap (white matt lacquered).	
Peso:		Note:	Rosone in metallo (laccato bianco opaco).	
Poids:		Notes:	Patère en métal (laquée blanc opaque).	

* Dimensions in centimeters





LIGHTING LED / LED LUMINOSO / LUMINEUSE LED









2700K

CODE CODICE CODE	LP STX122			
TECHNICAL INFO INFO TECNICHE INFOS TECHNIQUES	Lithing system: Sistema di illuminazione: Système d'éclairage:	Strip led Strip led Strip led	15W LED system	Included Incluso Inclus
	Wiring: Cablaggio: Câblage:	White cable + driver included Cavo bianco + driver incluso Câble blanc + transformateur inclus		Length: 3 m Lunghezza: 3 m Longueur: 3 m
	Light temperature: Temperatura luce: Température de la lumière:	Extra warm white led light 2700K Luce calda led bianco extra 2700K Lumière chaude LED blanc extra 2700K		
	Accessory on request: Accessorio su richiesta: Accessoire sur demande:	Dimmer Led Kit Dimmer Led Kit Dimmer Led Kit	On request: Su richiesta: Sur demande:	Dali driver
COLOURS COLORI COULEURS	LIGHTING COLOURS			
	 <p>LIGHT WHITE</p>			
	<p>MATT LACQUERED (METAL CEILING CAP)</p>  <p>ABSOLUTE WHITE (white RAL 9016 matching)</p>			
NOTES NOTE NOTES	 <p>metal ceiling cap included with 2 fixing steel cables 335 x 38 h 38 mm</p>			

LIGHTING LED / LED LUMINOSO / LUMINEUSE LED

3000K

CODE CODICE CODE	LP STX120			
TECHNICAL INFO INFO TECNICHE INFOS TECHNIQUES	Lithing system: Sistema di illuminazione: Système d'éclairage:	Strip led Strip led Strip led	15W LED system	Included Incluso Inclus
	Wiring: Cablaggio: Câblage:	White cable + driver included Cavo bianco + driver incluso Câble blanc + transformateur inclus		Length: 3 m Lunghezza: 3 m Longueur: 3 m
	Light temperature: Temperatura luce: Température de la lumière:	Warm white led light 3000K Luce calda led bianco 3000K Lumière chaude LED blanc 3000K		
	Accessory on request: Accessorio su richiesta: Accessoire sur demande:	Dimmer Led Kit Dimmer Led Kit Dimmer Led Kit	On request: Su richiesta: Sur demande:	Dali driver
COLOURS COLORI COULEURS	LIGHTING COLOURS			
	 <p>LIGHT WHITE</p>			
	<p>MATT LACQUERED (METAL CEILING CAP)</p>  <p>ABSOLUTE WHITE (white RAL 9016 matching)</p>			
NOTES NOTE NOTES	 <p>metal ceiling cap included with 2 fixing steel cables 335 x 38 h 38 mm</p>			



CODE CODICE CODE	LP STX121	    		
TECHNICAL INFO INFO TECNICHE INFOS TECHNIQUES	Lithing system: Sistema di illuminazione: Système d'éclairage:	Strip led Strip led Strip led	15W LED system	Included Incluso Inclus
	Wiring: Cablaggio: Câblage:	White cable + driver included Cavo bianco + driver incluso Câble blanc + transformateur inclus		Length: 3 m Lunghezza: 3 m Longueur: 3 m
	Light temperature: Temperatura luce: Température de la lumière:	Cool white led light 4000K Luce fredda led bianco 4000K Lumière froide LED blanc 4000K		
	Accessory on request: Accessorio su richiesta: Accessoire sur demande:	Dimmer Led Kit Dimmer Led Kit Dimmer Led Kit	On request: Su richiesta: Sur demande:	Dali driver
COLOURS COLORI COULEURS	LIGHTING COLOURS			
	 LIGHT WHITE			
	MATT LACQUERED (METAL CEILING CAP)			
	 (white RAL 9016 matching) ABSOLUTE WHITE			
NOTES NOTE NOTES	 metal ceiling cap included with 2 fixing steel cables 335 x 38 h 38 mm			

COMPONENTS / COMPONENTI / COMPOSANTS

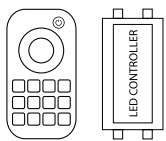
DIMMER LED KIT



Dimming remote control and LED controller

CODE CODICE CODE	LP DIM001 (LED controller)			
TECHNICAL INFO INFO TECNICHE INFOS TECHNIQUES	Dimensions: Dimensioni: Dimensions:	10 x 3 h 2 cm	Weight: Peso: Poids:	0,1 Kg
NOTES NOTE NOTES	LED controller (for nr.1 lamp). Remote control required. LED controller (per nr.1 lampada). Telecomando richiesto. LED controller (pour lampe nr.1). Télécommande requise.			
CODE CODICE CODE	LP DIM002 (remote control)			
TECHNICAL INFO INFO TECNICHE INFOS TECHNIQUES	Dimensions: Dimensioni: Dimensions:	12 x 5 h 2 cm	Weight: Peso: Poids:	0,1 Kg
NOTES NOTE NOTES	RF dimming remote controller, wireless remote 30m distance (for one or more lamps). Telecomando dimmerabile RF, telecomando wireless a 30 m di distanza (per una o più lampade). Télécommande à gradation RF, distance sans fil de 30 m (pour une ou plusieurs lampes). Inserted into the Giotto box if purchased at the same time. Inserito nella scatola Giotto se acquistato contemporaneamente. Inséré dans le carton Giotto si acheté en même temps.			

STILETTO Y 80

Design
Roberto Paoli

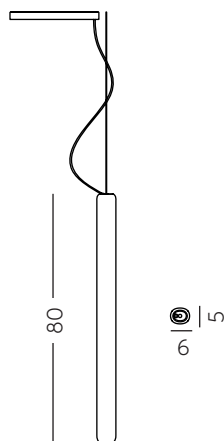





PRODUCT	Category:		Packaging dimensions:	
	Category:	Hanging lamp	Dimensioni imballaggio:	15 x 15 x 83 cm
	Categoria:	Lampada a sospensione	Dimensions emballage:	
	Catégorie:	Lampe à suspension		
	Years of production:		Packaging volume:	
Anno di produzione:	2020	Volume Imballaggio:	0,019 m ³	
Année de production:		Volume emballage:		
Materials:		Total weight:		
Materiali:	Polyethylene	Peso totale:	1,8 Kg	
Matériaux:	Polietilene	Poids total:		
	Polyéthylène			
Dimensions:		No. of cartons:		
Dimensioni:	6 x 5 h 80 cm	Nr. di imballi:	1	
Dimensions:		N°. de cartons:		
Weight:		Notes:		
Peso:	0,8 Kg	Note:	Metal ceiling cap (white matt lacquered).	
Poids:		Notes:	Rosone in metallo (laccato bianco opaco).	
			Patère en métal (laquée blanc opaque).	

* Dimensions in centimeters





LIGHTING LED / LED LUMINOSO / LUMINEUSE LED

2700K

CODE CODICE CODE	LP STY082			
TECHNICAL INFO INFO TECNICHE INFOS TECHNIQUES	Lithing system: Sistema di illuminazione: Système d'éclairage:	Flexible led tube Tubo flessibile led Tube flexible led	10W LED system	Included Incluso Inclus
	Wiring: Cablaggio: Câblage:	White cable + driver included Cavo bianco + driver incluso Câble blanc + transformateur inclus		Length: 3 m Lunghezza: 3 m Longueur: 3 m
	Light temperature: Temperatura luce: Température de la lumière:	Extra warm white led light 2700K Luce calda led bianco extra 2700K Lumière chaude LED blanc extra 2700K		
	Accessory on request: Accessorio su richiesta: Accessoire sur demande:	Dimmer Led Kit Dimmer Led Kit Dimmer Led Kit	On request: Su richiesta: Sur demande:	Dali driver
COLOURS COLORI COULEURS	LIGHTING COLOURS			
	 <p>LIGHT WHITE</p>			
	<p>MATT LACQUERED (METAL CEILING CAP)</p>  <p>ABSOLUTE WHITE (white RAL 9016 matching)</p>			
NOTES NOTE NOTES	 <p>metal ceiling cap included with 1 fixing steel cables 280 x 38 h 38 mm</p>			





LIGHTING LED / LED LUMINOSO / LUMINEUSE LED

3000K

CODE CODICE CODE	LP STY080			
TECHNICAL INFO INFO TECNICHE INFOS TECHNIQUES	Lithing system: Sistema di illuminazione: Système d'éclairage:	Flexible led tube Tubo flessibile led Tube flexible led	10W LED system	Included Incluso Inclus
	Wiring: Cablaggio: Câblage:	White cable + driver included Cavo bianco + driver incluso Câble blanc + transformateur inclus		Length: 3 m Lunghezza: 3 m Longueur: 3 m
	Light temperature: Temperatura luce: Température de la lumière:	Warm white led light 3000K Luce calda led bianco 3000K Lumière chaude LED blanc 3000K		
	Accessory on request: Accessorio su richiesta: Accessoire sur demande:	Dimmer Led Kit Dimmer Led Kit Dimmer Led Kit	On request: Su richiesta: Sur demande:	Dali driver
COLOURS COLORI COULEURS	LIGHTING COLOURS			
	 <p>LIGHT WHITE</p>			
	<p>MATT LACQUERED (METAL CEILING CAP)</p>  <p>ABSOLUTE WHITE (white RAL 9016 matching)</p>			
NOTES NOTE NOTES	 <p>metal ceiling cap included with 1 fixing steel cables 280 x 38 h 38 mm</p>			

LIGHTING LED / LED LUMINOSO / LUMINEUSE LED

4000K



CODE CODICE CODE	LP STY081			
TECHNICAL INFO INFO TECNICHE INFOS TECHNIQUES	Lithing system: Sistema di illuminazione: Système d'éclairage:	Flexible led tube Tubo flessibile led Tube flexible led	10W LED system	Included Incluso Inclus
	Wiring: Cablaggio: Câblage:	White cable + driver included Cavo bianco + driver incluso Câble blanc + transformateur inclus		Length: 3 m Lunghezza: 3 m Longueur: 3 m
	Light temperature: Temperatura luce: Température de la lumière:	Cool white led light 4000K Luce fredda led bianco 4000K Lumière froide LED blanc 4000K		
	Accessory on request: Accessorio su richiesta: Accessoire sur demande:	Dimmer Led Kit Dimmer Led Kit Dimmer Led Kit	On request: Su richiesta: Sur demande:	Dali driver
COLOURS COLORI COULEURS	LIGHTING COLOURS			
	 LIGHT WHITE			
	MATT LACQUERED (METAL CEILING CAP)			
	 ABSOLUTE WHITE (white RAL 9016 matching)			
NOTES NOTE NOTES	 metal ceiling cap included with 1 fixing steel cables 280 x 38 h 38 mm			

COMPONENTS / COMPONENTI / COMPOSANTS

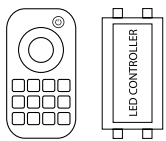
DIMMER LED KIT



Dimming remote control and LED controller

CODE CODICE CODE	LP DIM001 (LED controller)			
TECHNICAL INFO INFO TECNICHE INFOS TECHNIQUES	Dimensions: Dimensioni: Dimensions:	10 x 3 h 2 cm	Weight: Peso: Poids:	0,1 Kg
NOTES NOTE NOTES	LED controller (for nr.1 lamp). Remote control required. LED controller (per nr.1 lampada). Telecomando richiesto. LED controller (pour lampe nr.1). Télécommande requise.			
CODE CODICE CODE	LP DIM002 (remote control)			
TECHNICAL INFO INFO TECNICHE INFOS TECHNIQUES	Dimensions: Dimensioni: Dimensions:	12 x 5 h 2 mm	Weight: Peso: Poids:	0,1 Kg
NOTES NOTE NOTES	RF dimming remote controller, wireless remote 30m distance (for one or more lamps). Telecomando dimmerabile RF, telecomando wireless a 30 m di distanza (per una o più lampade). Télécommande à gradation RF, distance sans fil de 30 m (pour une ou plusieurs lampes).			
	Inserted into the Giotto box if purchased at the same time. Inserito nella scatola Giotto se acquistato contemporaneamente. Inséré dans le carton Giotto si acheté en même temps.			

STILETTO Y 120

Design
Roberto Paoli

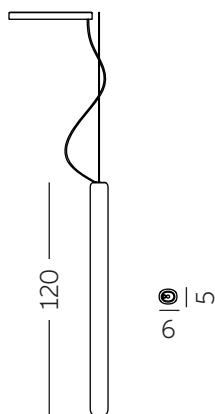





PRODUCT	Category: Categoria: Catégorie:	Hanging lamp Lampada a sospensione Lampe à suspension	PACKAGING	Packaging dimensions: Dimensioni imballaggio: Dimensions emballage:	15 x 15 x 123 cm
	Years of production: Anno di produzione: Année de production:	2020		Packaging volume: Volume Imballaggio: Volume emballage:	0,028 m ³
	Materials: Materiali: Matériaux:	Polyethylene Polietilene Polyéthylène		Total weight: Peso totale: Poids total:	2,7 Kg
	Dimensions: Dimensioni: Dimensions:	6 x 5 h 120 cm		No. of cartons: Nr. di imballi: N° de cartons:	1
	Weight: Peso: Poids:	1 Kg		Notes: Note: Notes:	Metal ceiling cap (white matt lacquered). Rosone in metallo (laccato bianco opaco). Patère en métal (laquée blanc opaque).

* Dimensions in centimeters





LIGHTING LED / LED LUMINOSO / LUMINEUSE LED

2700K

CODE CODICE CODE	LP STY122			
TECHNICAL INFO INFO TECNICHE INFOS TECHNIQUES	Lithing system: Sistema di illuminazione: Système d'éclairage:	Flexible led tube Tubo flessibile led Tube flexible led	15W LED system	Included Incluso Inclus
	Wiring: Cablaggio: Câblage:	White cable + driver included Cavo bianco + driver incluso Câble blanc + transformateur inclus		Length: 3 m Lunghezza: 3 m Longueur: 3 m
	Light temperature: Temperatura luce: Température de la lumière:	Extra warm white led light 2700K Luce calda led bianco extra 2700K Lumière chaude LED blanc extra 2700K		
	Accessory on request: Accessorio su richiesta: Accessoire sur demande:	Dimmer Led Kit Dimmer Led Kit Dimmer Led Kit	On request: Su richiesta: Sur demande:	Dali driver
COLOURS COLORI COULEURS	LIGHTING COLOURS			
	 LIGHT WHITE			
	MATT LACQUERED (METAL CEILING CAP)  (white RAL 9016 matching) ABSOLUTE WHITE			
NOTES NOTE NOTES	 metal ceiling cap included with 2 fixing steel cables 335 x 38 h 38 mm			









LIGHTING LED / LED LUMINOSO / LUMINEUSE LED

3000K

CODE CODICE CODE	LP STY120			
TECHNICAL INFO INFO TECNICHE INFOS TECHNIQUES	Lithing system: Sistema di illuminazione: Système d'éclairage:	Flexible led tube Tubo flessibile led Tube flexible led	15W LED system	Included Incluso Inclus
	Wiring: Cablaggio: Câblage:	White cable + driver included Cavo bianco + driver incluso Câble blanc + transformateur inclus		Length: 3 m Lunghezza: 3 m Longueur: 3 m
	Light temperature: Temperatura luce: Température de la lumière:	Warm white led light 3000K Luce calda led bianco 3000K Lumière chaude LED blanc 3000K		
	Accessory on request: Accessorio su richiesta: Accessoire sur demande:	Dimmer Led Kit Dimmer Led Kit Dimmer Led Kit	On request: Su richiesta: Sur demande:	Dali driver
COLOURS COLORI COULEURS	LIGHTING COLOURS			
	 LIGHT WHITE			
	MATT LACQUERED (METAL CEILING CAP)  (white RAL 9016 matching) ABSOLUTE WHITE			
NOTES NOTE NOTES	 metal ceiling cap included with 2 fixing steel cables 335 x 38 h 38 mm			

LIGHTING LED / LED LUMINOSO / LUMINEUSE LED

4000K



CODE CODICE CODE	LP STY121	    		
TECHNICAL INFO INFO TECNICHE INFOS TECHNIQUES	Lithing system: Sistema di illuminazione: Système d'éclairage:	Flexible led tube Tubo flessibile led Tube flexible led	15W LED system	Included Incluso Inclus
	Wiring: Cablaggio: Câblage:	White cable + driver included Cavo bianco + driver incluso Câble blanc + transformateur inclus		Length: 3 m Lunghezza: 3 m Longueur: 3 m
	Light temperature: Temperatura luce: Température de la lumière:	Cool white led light 4000K Luce fredda led bianco 4000K Lumière froide LED blanc 4000K		
	Accessory on request: Accessorio su richiesta: Accessoire sur demande:	Dimmer Led Kit Dimmer Led Kit Dimmer Led Kit	On request: Su richiesta: Sur demande:	Dali driver
COLOURS COLORI COULEURS	LIGHTING COLOURS			
	 LIGHT WHITE			
	MATT LACQUERED (METAL CEILING CAP)			
	 (white RAL 9016 matching) ABSOLUTE WHITE			
NOTES NOTE NOTES	 metal ceiling cap included with 2 fixing steel cables 335 x 38 h 38 mm			

COMPONENTS / COMPONENTI / COMPOSANTS

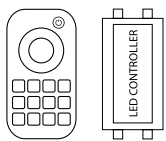
DIMMER LED KIT



Dimming remote control and LED controller

CODE CODICE CODE	LP DIM001 (LED controller)			
TECHNICAL INFO INFO TECNICHE INFOS TECHNIQUES	Dimensions: Dimensioni: Dimensions:	10 x 3 h 2 cm	Weight: Peso: Poids:	0,1 Kg
NOTES NOTE NOTES	LED controller (for nr.1 lamp). Remote control required. LED controller (per nr.1 lampada). Telecomando richiesto. LED controller (pour lampe nr.1). Télécommande requise.			
CODE CODICE CODE	LP DIM002 (remote control)			
TECHNICAL INFO INFO TECNICHE INFOS TECHNIQUES	Dimensions: Dimensioni: Dimensions:	12 x 5 h 2 cm	Weight: Peso: Poids:	0,1 Kg
NOTES NOTE NOTES	RF dimming remote controller, wireless remote 30m distance (for one or more lamps). Telecomando dimmerabile RF, telecomando wireless a 30 m di distanza (per una o più lampade). Télécommande à gradation RF, distance sans fil de 30 m (pour une ou plusieurs lampes). Inserted into the Giotto box if purchased at the same time. Inserito nella scatola Giotto se acquistato contemporaneamente. Inséré dans le carton Giotto si acheté en même temps.			

STILETTO APPLIQUE 80

Design
Roberto Paoli

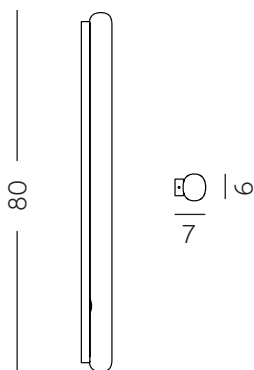







PRODUCT	Category: Categoria: Catégorie:	Wall/Ceiling lamp Lampada da muro Applique	PACKAGING	Packaging dimensions: Dimensioni imballaggio: Dimensions emballage:	15 x 15 x 83 cm
	Years of production: Anno di produzione: Année de production:	2020		Packaging volume: Volume Imballaggio: Volume emballage:	0,019 m ³
	Materials: Materiali: Matériaux:	Polyethylene Polietilene Polyéthylène		Total weight: Peso totale: Poids total:	2 Kg
	Dimensions: Dimensioni: Dimensions:	6 x 7 h 80 cm		No. of cartons: Nr. di imballi: N° de cartons:	1
	Weight: Peso: Poids:	1 Kg		Notes: Note: Notes:	

* Dimensions in centimeters







LIGHTING LED / LED LUMINOSO / LUMINEUSE LED

2700K

CODE CODICE CODE	LP STW082	   		
TECHNICAL INFO INFO TECNICHE INFOS TECHNIQUES	Lithing system: Sistema di illuminazione: Système d'éclairage:	Strip led Strip led Strip led	10W LED system	Included Incluso Inclus
	Wiring: Cablaggio: Câblage:	White cable + driver included Cavo bianco + driver incluso Câble blanc + transformateur inclus		Length: 3 m Lunghezza: 3 m Longueur: 3 m
	Light temperature: Temperatura luce: Température de la lumière:	Extra warm white led light 2700K Luce calda led bianco extra 2700K Lumière chaude LED blanc extra 2700K		
	Accessory on request: Accessorio su richiesta: Accessoire sur demande:	Dimmer Led Kit Dimmer Led Kit Dimmer Led Kit	On request: Su richiesta: Sur demande:	Dali driver
COLOURS COLORI COULEURS	LIGHTING COLOURS			
	 <p>LIGHT WHITE</p>			
	<p>MATT LACQUERED (METAL)</p>  <p>ABSOLUTE WHITE (white RAL 9016 matching)</p>			
NOTES NOTE NOTES				



LIGHTING LED / LED LUMINOSO / LUMINEUSE LED

3000K

CODE CODICE CODE	LP STW080	   		
TECHNICAL INFO INFO TECNICHE INFOS TECHNIQUES	Lithing system: Sistema di illuminazione: Système d'éclairage:	Strip led Strip led Strip led	10W LED system	Included Incluso Inclus
	Wiring: Cablaggio: Câblage:	White cable + driver included Cavo bianco + driver incluso Câble blanc + transformateur inclus		Length: 3 m Lunghezza: 3 m Longueur: 3 m
	Light temperature: Temperatura luce: Température de la lumière:	Warm white led light 3000K Luce calda led bianco 3000K Lumière chaude LED blanc 3000K		
	Accessory on request: Accessorio su richiesta: Accessoire sur demande:	Dimmer Led Kit Dimmer Led Kit Dimmer Led Kit	On request: Su richiesta: Sur demande:	Dali driver
COLOURS COLORI COULEURS	LIGHTING COLOURS			
	 <p>LIGHT WHITE</p>			
	<p>MATT LACQUERED (METAL)</p>  <p>ABSOLUTE WHITE (white RAL 9016 matching)</p>			
NOTES NOTE NOTES				

LIGHTING LED / LED LUMINOSO / LUMINEUSE LED

4000K



CODE CODICE CODE	LP STW081			
TECHNICAL INFO INFO TECNICHE INFOS TECHNIQUES	Lithing system: Sistema di illuminazione: Système d'éclairage:	Strip led Strip led Strip led	10W LED system	Included Incluso Inclus
	Wiring: Cablaggio: Câblage:	White cable + driver included Cavo bianco + driver incluso Câble blanc + transformateur inclus		Length: 3 m Lunghezza: 3 m Longueur: 3 m
	Light temperature: Temperatura luce: Température de la lumière:	Cool white led light 4000K Luce fredda led bianco 4000K Lumière froide LED blanc 4000K		
	Accessory on request: Accessorio su richiesta: Accessoire sur demande:	Dimmer Led Kit Dimmer Led Kit Dimmer Led Kit	On request: Su richiesta: Sur demande:	Dali driver
COLOURS COLORI COULEURS	LIGHTING COLOURS			
	 LIGHT WHITE			
NOTES NOTE NOTES	MATT LACQUERED (METAL)			
	 ABSOLUTE WHITE (white RAL 9016 matching)			

COMPONENTS / COMPONENTI / COMPOSANTS

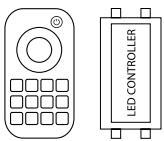
DIMMER LED KIT



Dimming remote control and LED controller

CODE CODICE CODE	LP DIM001 (LED controller)			
TECHNICAL INFO INFO TECNICHE INFOS TECHNIQUES	Dimensions: Dimensioni: Dimensions:	10 x 3 h 2 cm	Weight: Peso: Poids:	0,1 Kg
NOTES NOTE NOTES	LED controller (for nr.1 lamp). Remote control required. LED controller (per nr.1 lampada). Telecomando richiesto. LED controller (pour lampe nr.1). Télécommande requise.			
CODE CODICE CODE	LP DIM002 (remote control)			
TECHNICAL INFO INFO TECNICHE INFOS TECHNIQUES	Dimensions: Dimensioni: Dimensions:	12 x 5 h 2 cm	Weight: Peso: Poids:	0,1 Kg
NOTES NOTE NOTES	RF dimming remote controller, wireless remote 30m distance (for one or more lamps). Telecomando dimmerabile RF, telecomando wireless a 30 m di distanza (per una o più lampade). Télécommande à gradation RF, distance sans fil de 30 m (pour une ou plusieurs lampes).			
	Inserted into the Giotto box if purchased at the same time. Inserito nella scatola Giotto se acquistato contemporaneamente. Inséré dans le carton Giotto si acheté en même temps.			

STILETTO APPLIQUE 120

Design
Roberto Paoli

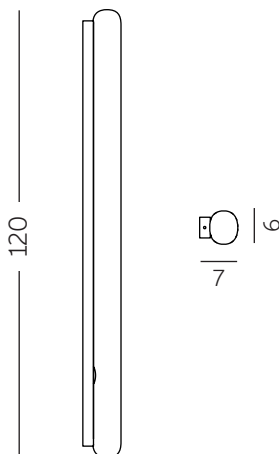







PRODUCT	Category: Categoria: Catégorie:	Wall/Ceiling lamp Lampada da muro Applique	PACKAGING	Packaging dimensions: Dimensioni imballaggio: Dimensions emballage:	15 x 15 x 123 cm
	Years of production: Anno di produzione: Année de production:	2020		Packaging volume: Volume Imballaggio: Volume emballage:	0,028 m ³
	Materials: Materiali: Matériaux:	Polyethylene Polietilene Polyéthylène		Total weight: Peso totale: Poids total:	3 Kg
	Dimensions: Dimensioni: Dimensions:	6 x 7 h 120 cm		No. of cartons: Nr. di imballi: N° de cartons:	1
	Weight: Peso: Poids:	1,3 Kg		Notes: Note: Notes:	

* Dimensions in centimeters







LIGHTING LED / LED LUMINOSO / LUMINEUSE LED

2700K

CODE CODICE CODE	LP STW122	    		
TECHNICAL INFO INFO TECNICHE INFOS TECHNIQUES	Lithing system: Sistema di illuminazione: Système d'éclairage:	Strip led Strip led Strip led	15W LED system	Included Incluso Inclus
	Wiring: Cablaggio: Câblage:	White cable + driver included Cavo bianco + driver incluso Câble blanc + transformateur inclus		Length: 3 m Lunghezza: 3 m Longueur: 3 m
	Light temperature: Temperatura luce: Température de la lumière:	Extra warm white led light 2700K Luce calda led bianco extra 2700K Lumière chaude LED blanc extra 2700K		
	Accessory on request: Accessorio su richiesta: Accessoire sur demande:	Dimmer Led Kit Dimmer Led Kit Dimmer Led Kit	On request: Su richiesta: Sur demande:	Dali driver
COLOURS COLORI COULEURS	LIGHTING COLOURS			
	 <p>LIGHT WHITE</p>			
	<p>MATT LACQUERED (METAL)</p>  <p>ABSOLUTE WHITE (white RAL 9016 matching)</p>			
NOTES NOTE NOTES				







LIGHTING LED / LED LUMINOSO / LUMINEUSE LED

3000K

CODE CODICE CODE	LP STW120	    		
TECHNICAL INFO INFO TECNICHE INFOS TECHNIQUES	Lithing system: Sistema di illuminazione: Système d'éclairage:	Strip led Strip led Strip led	15W LED system	Included Incluso Inclus
	Wiring: Cablaggio: Câblage:	White cable + driver included Cavo bianco + driver incluso Câble blanc + transformateur inclus		Length: 3 m Lunghezza: 3 m Longueur: 3 m
	Light temperature: Temperatura luce: Température de la lumière:	Warm white led light 3000K Luce calda led bianco 3000K Lumière chaude LED blanc 3000K		
	Accessory on request: Accessorio su richiesta: Accessoire sur demande:	Dimmer Led Kit Dimmer Led Kit Dimmer Led Kit	On request: Su richiesta: Sur demande:	Dali driver
COLOURS COLORI COULEURS	LIGHTING COLOURS			
	 <p>LIGHT WHITE</p>			
	<p>MATT LACQUERED (METAL)</p>  <p>ABSOLUTE WHITE (white RAL 9016 matching)</p>			
NOTES NOTE NOTES				

LIGHTING LED / LED LUMINOSO / LUMINEUSE LED

4000K



CODE CODICE CODE	LP STW121	    		
TECHNICAL INFO INFO TECNICHE INFOS TECHNIQUES	Lithing system: Sistema di illuminazione: Système d'éclairage:	Strip led Strip led Strip led	15W LED system	Included Incluso Inclus
	Wiring: Cablaggio: Câblage:	White cable + driver included Cavo bianco + driver incluso Câble blanc + transformateur inclus		Length: 3 m Lunghezza: 3 m Longueur: 3 m
	Light temperature: Temperatura luce: Température de la lumière:	Cool white led light 4000K Luce fredda led bianco 4000K Lumière froide LED blanc 4000K		
	Accessory on request: Accessorio su richiesta: Accessoire sur demande:	Dimmer Led Kit Dimmer Led Kit Dimmer Led Kit	On request: Su richiesta: Sur demande:	Dali driver
COLOURS COLORI COULEURS	LIGHTING COLOURS			
	 LIGHT WHITE			
	MATT LACQUERED (METAL)			
	 (white RAL 9016 matching) ABSOLUTE WHITE			
NOTES NOTE NOTES				

COMPONENTS / COMPONENTI / COMPOSANTS

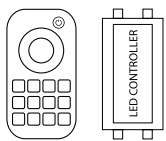
DIMMER LED KIT



Dimming remote control and LED controller

CODE CODICE CODE	LP DIM001 (LED controller)			
TECHNICAL INFO INFO TECNICHE INFOS TECHNIQUES	Dimensions: Dimensioni: Dimensions:	10 x 3 h 2 cm	Weight: Peso: Poids:	0,1 Kg
NOTES NOTE NOTES	LED controller (for nr.1 lamp). Remote control required. LED controller (per nr.1 lampada). Telecomando richiesto. LED controller (pour lampe nr.1). Télécommande requise.			
CODE CODICE CODE	LP DIM002 (remote control)			
TECHNICAL INFO INFO TECNICHE INFOS TECHNIQUES	Dimensions: Dimensioni: Dimensions:	12 x 5 h 2 cm	Weight: Peso: Poids:	0,1 Kg
NOTES NOTE NOTES	RF dimming remote controller, wireless remote 30m distance (for one or more lamps). Telecomando dimmerabile RF, telecomando wireless a 30 m di distanza (per una o più lampade). Télécommande à gradation RF, distance sans fil de 30 m (pour une ou plusieurs lampes).			
	Inserted into the Giotto box if purchased at the same time. Inserito nella scatola Giotto se acquistato contemporaneamente. Inséré dans le carton Giotto si acheté en même temps.			

STILETTO SHARD 80

Design
Roberto Paoli

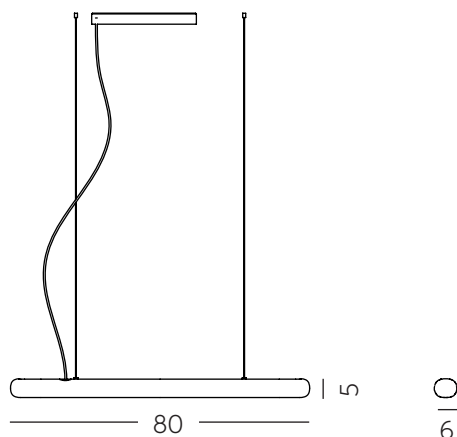







PRODUCT	Category: Categoria: Catégorie:	Hanging lamp Lampada a sospensione Lampe à suspension	PACKAGING	Packaging dimensions: Dimensioni imballaggio: Dimensions emballage:	15 x 15 x 83 cm
	Years of production: Anno di produzione: Année de production:	2020		Packaging volume: Volume Imballaggio: Volume emballage:	0,019 m ³
	Materials: Materiali: Matériaux:	Polyethylene Polietilene Polyéthylène		Total weight: Peso totale: Poids total:	1,6 Kg
	Dimensions: Dimensioni: Dimensions:	80 x 6 h 5 cm		No. of cartons: Nr. di imballi: N° de cartons:	1
	Weight: Peso: Poids:	0,6 Kg		Notes: Note: Notes:	Metal ceiling cap (white matt lacquered). Rosone in metallo (laccato bianco opaco). Patère en métal (laquée blanc opaque).

* Dimensions in centimeters







LIGHTING LED / LED LUMINOSO / LUMINEUSE LED





2700K

CODE CODICE CODE	LP SXX082	   		
TECHNICAL INFO INFO TECNICHE INFOS TECHNIQUES	Lithing system: Sistema di illuminazione: Système d'éclairage:	Strip led Strip led Strip led	10W LED system	Included Incluso Inclus
	Wiring: Cablaggio: Câblage:	White cable + driver included Cavo bianco + driver incluso Câble blanc + transformateur inclus		Length: 3 m Lunghezza: 3 m Longueur: 3 m
	Light temperature: Temperatura luce: Température de la lumière:	Extra warm white led light 2700K Luce calda led bianco extra 2700K Lumière chaude LED blanc extra 2700K		
	Accessory on request: Accessorio su richiesta: Accessoire sur demande:	Dimmer Led Kit Dimmer Led Kit Dimmer Led Kit	On request: Su richiesta: Sur demande:	Dali driver
COLOURS COLORI COULEURS	SPECIAL LIGHTING COLOURS (MATT FINISH)			
	 <p>GREY VEININGS</p>			
	<p>MATT LACQUERED (METAL CEILING CAP)</p>  <p>(white RAL 9016 matching)</p> <p>ABSOLUTE WHITE</p>			
NOTES NOTE NOTES	 <p>metal ceiling cap included with 2 fixing steel cables 280 x 38 h 38 mm</p>			

LIGHTING LED / LED LUMINOSO / LUMINEUSE LED

3000K

CODE CODICE CODE	LP SXX080	   		
TECHNICAL INFO INFO TECNICHE INFOS TECHNIQUES	Lithing system: Sistema di illuminazione: Système d'éclairage:	Strip led Strip led Strip led	10W LED system	Included Incluso Inclus
	Wiring: Cablaggio: Câblage:	White cable + driver included Cavo bianco + driver incluso Câble blanc + transformateur inclus		Length: 3 m Lunghezza: 3 m Longueur: 3 m
	Light temperature: Temperatura luce: Température de la lumière:	Warm white led light 3000K Luce calda led bianco 3000K Lumière chaude LED blanc 3000K		
	Accessory on request: Accessorio su richiesta: Accessoire sur demande:	Dimmer Led Kit Dimmer Led Kit Dimmer Led Kit	On request: Su richiesta: Sur demande:	Dali driver
COLOURS COLORI COULEURS	SPECIAL LIGHTING COLOURS (MATT FINISH)			
	 <p>GREY VEININGS</p>			
	<p>MATT LACQUERED (METAL CEILING CAP)</p>  <p>(white RAL 9016 matching)</p> <p>ABSOLUTE WHITE</p>			
NOTES NOTE NOTES	 <p>metal ceiling cap included with 2 fixing steel cables 280 x 38 h 38 mm</p>			



CODE CODICE CODE	LP SSX081			
TECHNICAL INFO INFO TECNICHE INFOS TECHNIQUES	Lithing system: Sistema di illuminazione: Système d'éclairage:	Strip led Strip led Strip led	10W LED system	Included Incluso Inclus
	Wiring: Cablaggio: Câblage:	White cable + driver included Cavo bianco + driver incluso Câble blanc + transformateur inclus		Length: 3 m Lunghezza: 3 m Longueur: 3 m
	Light temperature: Temperatura luce: Température de la lumière:	Cool white led light 4000K Luce fredda led bianco 4000K Lumière froide LED blanc 4000K		
	Accessory on request: Accessorio su richiesta: Accessoire sur demande:	Dimmer Led Kit Dimmer Led Kit Dimmer Led Kit	On request: Su richiesta: Sur demande:	Dali driver
COLOURS COLORI COULEURS	SPECIAL LIGHTING COLOURS (MATT FINISH)			
	 GREY VEININGS			
	MATT LACQUERED (METAL CEILING CAP)  ABSOLUTE WHITE (white RAL 9016 matching)			
NOTES NOTE NOTES	 metal ceiling cap included with 2 fixing steel cables 280 x 38 h 38 mm			

COMPONENTS / COMPONENTI / COMPOSANTS

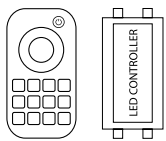
DIMMER LED KIT



Dimming remote control and LED controller

CODE CODICE CODE	LP DIM001 (LED controller)			
TECHNICAL INFO INFO TECNICHE INFOS TECHNIQUES	Dimensions: Dimensioni: Dimensions:	10 x 3 h 2 cm	Weight: Peso: Poids:	0,1 Kg
NOTES NOTE NOTES	LED controller (for nr.1 lamp). Remote control required. LED controller (per nr.1 lampada). Telecomando richiesto. LED controller (pour lampe nr.1). Télécommande requise.			
CODE CODICE CODE	LP DIM002 (remote control)			
TECHNICAL INFO INFO TECNICHE INFOS TECHNIQUES	Dimensions: Dimensioni: Dimensions:	12 x 5 h 2 mm	Weight: Peso: Poids:	0,1 Kg
NOTES NOTE NOTES	RF dimming remote controller, wireless remote 30m distance (for one or more lamps). Telecomando dimmerabile RF, telecomando wireless a 30 m di distanza (per una o più lampade). Télécommande à gradation RF, distance sans fil de 30 m (pour une ou plusieurs lampes). Inserted into the Giotto box if purchased at the same time. Inserito nella scatola Giotto se acquistato contemporaneamente. Inséré dans le carton Giotto si acheté en même temps.			

STILETTO SHARD 120

Design
Roberto Paoli

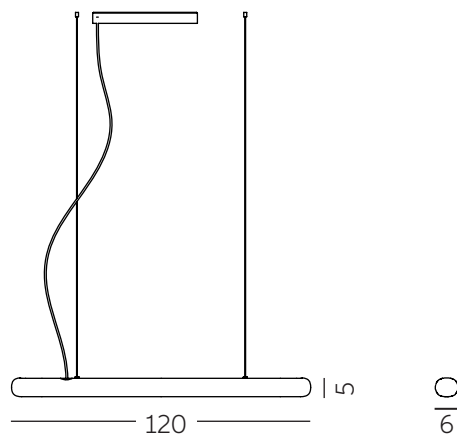





PRODUCT	Category:		Packaging dimensions:	
	Category:	Hanging lamp	Dimensioni imballaggio:	15 x 15 x 123 cm
	Categoria:	Lampada a sospensione	Dimensions emballage:	
	Catégorie:	Lampe à suspension		
	Years of production:	2020	Packaging volume:	0,028 m ³
Anno di produzione:		Volume Imballaggio:		
Année de production:		Volume emballage:		
Materials:	Polyethylene	Total weight:	2,5 Kg	
Materiali:	Polietilene	Peso totale:		
Matériaux:	Polyéthylène	Poids total:		
Dimensions:	120 x 6 h 5 cm	No. of cartons:	1	
Dimensioni:		Nr. di imballi:		
Dimensions:		N° de cartons:		
Weight:	0,8 Kg	Notes:	Metal ceiling cap (white matt lacquered).	
Peso:		Note:	Rosone in metallo (laccato bianco opaco).	
Poids:		Notes:	Patère en métal (laquée blanc opaque).	

* Dimensions in centimeters





LIGHTING LED / LED LUMINOSO / LUMINEUSE LED









2700K

CODE CODICE CODE	LP SSX122			
TECHNICAL INFO INFO TECNICHE INFOS TECHNIQUES	Lithing system: Sistema di illuminazione: Système d'éclairage:	Strip led Strip led Strip led	15W LED system	Included Incluso Inclus
	Wiring: Cablaggio: Câblage:	White cable + driver included Cavo bianco + driver incluso Câble blanc + transformateur inclus		Length: 3 m Lunghezza: 3 m Longueur: 3 m
	Light temperature: Temperatura luce: Température de la lumière:	Extra warm white led light 2700K Luce calda led bianco extra 2700K Lumière chaude LED blanc extra 2700K		
	Accessory on request: Accessorio su richiesta: Accessoire sur demande:	Dimmer Led Kit Dimmer Led Kit Dimmer Led Kit	On request: Su richiesta: Sur demande:	Dali driver
COLOURS COLORI COULEURS	SPECIAL LIGHTING COLOURS (MATT FINISH)			
	 <p>GREY VEININGS</p>			
	<p>MATT LACQUERED (METAL CEILING CAP)</p>  <p>(white RAL 9016 matching)</p> <p>ABSOLUTE WHITE</p>			
NOTES NOTE NOTES	 <p>metal ceiling cap included with 2 fixing steel cables 335 x 38 h 38 mm</p>			

LIGHTING LED / LED LUMINOSO / LUMINEUSE LED

3000K

CODE CODICE CODE	LP SSX120			
TECHNICAL INFO INFO TECNICHE INFOS TECHNIQUES	Lithing system: Sistema di illuminazione: Système d'éclairage:	Strip led Strip led Strip led	15W LED system	Included Incluso Inclus
	Wiring: Cablaggio: Câblage:	White cable + driver included Cavo bianco + driver incluso Câble blanc + transformateur inclus		Length: 3 m Lunghezza: 3 m Longueur: 3 m
	Light temperature: Temperatura luce: Température de la lumière:	Warm white led light 3000K Luce calda led bianco 3000K Lumière chaude LED blanc 3000K		
	Accessory on request: Accessorio su richiesta: Accessoire sur demande:	Dimmer Led Kit Dimmer Led Kit Dimmer Led Kit	On request: Su richiesta: Sur demande:	Dali driver
COLOURS COLORI COULEURS	SPECIAL LIGHTING COLOURS (MATT FINISH)			
	 <p>GREY VEININGS</p>			
	<p>MATT LACQUERED (METAL CEILING CAP)</p>  <p>(white RAL 9016 matching)</p> <p>ABSOLUTE WHITE</p>			
NOTES NOTE NOTES	 <p>metal ceiling cap included with 2 fixing steel cables 335 x 38 h 38 mm</p>			



CODE CODICE CODE	LP SSX121	    		
TECHNICAL INFO INFO TECNICHE INFOS TECHNIQUES	Lithing system: Sistema di illuminazione: Système d'éclairage:	Strip led Strip led Strip led	15W LED system	Included Incluso Inclus
	Wiring: Cablaggio: Câblage:	White cable + driver included Cavo bianco + driver incluso Câble blanc + transformateur inclus		Length: 3 m Lunghezza: 3 m Longueur: 3 m
	Light temperature: Temperatura luce: Température de la lumière:	Cool white led light 4000K Luce fredda led bianco 4000K Lumière froide LED blanc 4000K		
	Accessory on request: Accessorio su richiesta: Accessoire sur demande:	Dimmer Led Kit Dimmer Led Kit Dimmer Led Kit	On request: Su richiesta: Sur demande:	Dali driver
COLOURS COLORI COULEURS	SPECIAL LIGHTING COLOURS (MATT FINISH)			
	 <p>GREY VEININGS</p>			
NOTES NOTE NOTES	MATT LACQUERED (METAL CEILING CAP)			
	 <p>ABSOLUTE WHITE (white RAL 9016 matching)</p>			
		 <p>metal ceiling cap included with 2 fixing steel cables 335 x 38 h 38 mm</p>		

COMPONENTS / COMPONENTI / COMPOSANTS

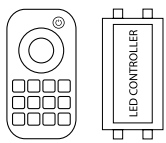
DIMMER LED KIT



Dimming remote control and LED controller

CODE CODICE CODE	LP DIM001 (LED controller)			
TECHNICAL INFO INFO TECNICHE INFOS TECHNIQUES	Dimensions: Dimensioni: Dimensions:	10 x 3 h 2 cm	Weight: Peso: Poids:	0,1 Kg
NOTES NOTE NOTES	LED controller (for nr.1 lamp). Remote control required. LED controller (per nr.1 lampada). Telecomando richiesto. LED controller (pour lampe nr.1). Télécommande requise.			
CODE CODICE CODE	LP DIM002 (remote control)			
TECHNICAL INFO INFO TECNICHE INFOS TECHNIQUES	Dimensions: Dimensioni: Dimensions:	12 x 5 h 2 cm	Weight: Peso: Poids:	0,1 Kg
NOTES NOTE NOTES	RF dimming remote controller, wireless remote 30m distance (for one or more lamps). Telecomando dimmerabile RF, telecomando wireless a 30 m di distanza (per una o più lampade). Télécommande à gradation RF, distance sans fil de 30 m (pour une ou plusieurs lampes). Inserted into the Giotto box if purchased at the same time. Inserito nella scatola Giotto se acquistato contemporaneamente. Inséré dans le carton Giotto si acheté en même temps.			

STILETTO SHARD APPLIQUE 80

Design
Roberto Paoli

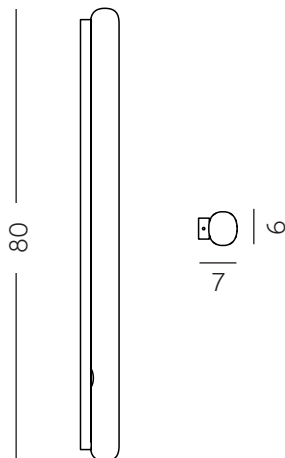







PRODUCT	Category: Categoria: Catégorie:	Wall/Ceiling lamp Lampada da muro Applique	PACKAGING	Packaging dimensions: Dimensioni imballaggio: Dimensions emballage:	15 x 15 x 83 cm
	Years of production: Anno di produzione: Année de production:	2020		Packaging volume: Volume Imballaggio: Volume emballage:	0,019 m ³
	Materials: Materiali: Matériaux:	Polyethylene Polietilene Polyéthylène		Total weight: Peso totale: Poids total:	2 Kg
	Dimensions: Dimensioni: Dimensions:	6 x 7 h 80 cm		No. of cartons: Nr. di imballi: N° de cartons:	1
	Weight: Peso: Poids:	1 Kg		Notes: Note: Notes:	

* Dimensions in centimeters







LIGHTING LED / LED LUMINOSO / LUMINEUSE LED

2700K

CODE CODICE CODE	LP SSW082	   		
TECHNICAL INFO INFO TECNICHE INFOS TECHNIQUES	Lithing system: Sistema di illuminazione: Système d'éclairage:	Flexible led tube Tubo flessibile led Tube led	10W LED system	Included Incluso Inclus
	Wiring: Cablaggio: Câblage:	White cable + driver included Cavo bianco + driver incluso Câble blanc + transformateur inclus		Length: 3 m Lunghezza: 3 m Longueur: 3 m
	Light temperature: Temperatura luce: Température de la lumière:	Extra warm white led light 2700K Luce calda led bianco extra 2700K Lumière chaude LED blanc extra 2700K		
	Accessory on request: Accessorio su richiesta: Accessoire sur demande:	Dimmer Led Kit Dimmer Led Kit Dimmer Led Kit	On request: Su richiesta: Sur demande:	Dali driver
COLOURS COLORI COULEURS	SPECIAL LIGHTING COLOURS (MATT FINISH)			
	 <p>GREY VEININGS</p>			
	<p>MATT LACQUERED (METAL)</p>  <p>ABSOLUTE WHITE (white RAL 9016 matching)</p>			
NOTES NOTE NOTES				







LIGHTING LED / LED LUMINOSO / LUMINEUSE LED

3000K

CODE CODICE CODE	LP SSW080	   		
TECHNICAL INFO INFO TECNICHE INFOS TECHNIQUES	Lithing system: Sistema di illuminazione: Système d'éclairage:	Flexible led tube Tubo flessibile led Tube led	10W LED system	Included Incluso Inclus
	Wiring: Cablaggio: Câblage:	White cable + driver included Cavo bianco + driver incluso Câble blanc + transformateur inclus		Length: 3 m Lunghezza: 3 m Longueur: 3 m
	Light temperature: Temperatura luce: Température de la lumière:	Warm white led light 3000K Luce calda led bianco 3000K Lumière chaude LED blanc 3000K		
	Accessory on request: Accessorio su richiesta: Accessoire sur demande:	Dimmer Led Kit Dimmer Led Kit Dimmer Led Kit	On request: Su richiesta: Sur demande:	Dali driver
COLOURS COLORI COULEURS	SPECIAL LIGHTING COLOURS (MATT FINISH)			
	 <p>GREY VEININGS</p>			
	<p>MATT LACQUERED (METAL)</p>  <p>ABSOLUTE WHITE (white RAL 9016 matching)</p>			
NOTES NOTE NOTES				

LIGHTING LED / LED LUMINOSO / LUMINEUSE LED

4000K



CODE CODICE CODE	LP SSW081	    		
TECHNICAL INFO INFO TECNICHE INFOS TECHNIQUES	Lithing system: Sistema di illuminazione: Système d'éclairage:	Flexible led tube Tubo flessibile led Tube led	10W LED system	Included Incluso Inclus
	Wiring: Cablaggio: Câblage:	White cable + driver included Cavo bianco + driver incluso Câble blanc + transformateur inclus		Length: 3 m Lunghezza: 3 m Longueur: 3 m
	Light temperature: Temperatura luce: Température de la lumière:	Cool white led light 4000K Luce fredda led bianco 4000K Lumière froide LED blanc 4000K		
	Accessory on request: Accessorio su richiesta: Accessoire sur demande:	Dimmer Led Kit Dimmer Led Kit Dimmer Led Kit	On request: Su richiesta: Sur demande:	Dali driver
COLOURS COLORI COULEURS	SPECIAL LIGHTING COLOURS (MATT FINISH)			
	 <p>GREY VEININGS</p>			
	<p>MATT LACQUERED (METAL)</p>  <p>ABSOLUTE WHITE</p> <p>(white RAL 9016 matching)</p>			
NOTES NOTE NOTES				

COMPONENTS / COMPONENTI / COMPOSANTS

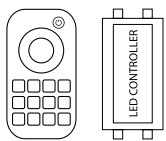
DIMMER LED KIT



Dimming remote control and LED controller

CODE CODICE CODE	LP DIM001 (LED controller)			
TECHNICAL INFO INFO TECNICHE INFOS TECHNIQUES	Dimensions: Dimensioni: Dimensions:	10 x 3 h 2 cm	Weight: Peso: Poids:	0,1 Kg
NOTES NOTE NOTES	LED controller (for nr.1 lamp). Remote control required. LED controller (per nr.1 lampada). Telecomando richiesto. LED controller (pour lampe nr.1). Télécommande requise.			
CODE CODICE CODE	LP DIM002 (remote control)			
TECHNICAL INFO INFO TECNICHE INFOS TECHNIQUES	Dimensions: Dimensioni: Dimensions:	12 x 5 h 2 cm	Weight: Peso: Poids:	0,1 Kg
NOTES NOTE NOTES	RF dimming remote controller, wireless remote 30m distance (for one or more lamps). Telecomando dimmerabile RF, telecomando wireless a 30 m di distanza (per una o più lampade). Télécommande à gradation RF, distance sans fil de 30 m (pour une ou plusieurs lampes).			
	Inserted into the Giotto box if purchased at the same time. Inserito nella scatola Giotto se acquistato contemporaneamente. Inséré dans le carton Giotto si acheté en même temps.			

STILETTO SHARD APPLIQUE 120

Design
Roberto Paoli

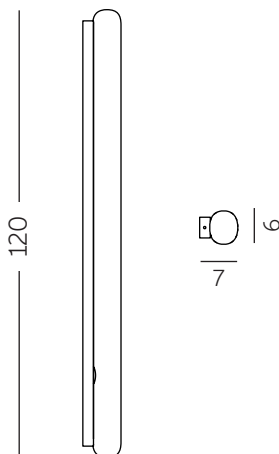



PRODUCT	Category: Categoria: Catégorie:	Wall/Ceiling lamp Lampada da muro Applique	PACKAGING	Packaging dimensions: Dimensioni imballaggio: Dimensions emballage:	15 x 15 x 123 cm
	Years of production: Anno di produzione: Année de production:	2020		Packaging volume: Volume Imballaggio: Volume emballage:	0,028 m ³
	Materials: Materiali: Matériaux:	Polyethylene Polietilene Polyéthylène		Total weight: Peso totale: Poids total:	3 Kg
	Dimensions: Dimensioni: Dimensions:	6 x 7 h 120 cm		No. of cartons: Nr. di imballi: N° de cartons:	1
	Weight: Peso: Poids:	1,3 Kg		Notes: Note: Notes:	

* Dimensions in centimeters



LIGHTING LED / LED LUMINOSO / LUMINEUSE LED

2700K

CODE CODICE CODE	LP SSW122			
TECHNICAL INFO INFO TECNICHE INFOS TECHNIQUES	Lithing system: Sistema di illuminazione: Système d'éclairage:	Flexible led tube Tubo flessibile led Tube led	15W LED system	Included Incluso Inclus
	Wiring: Cablaggio: Câblage:	White cable + driver included Cavo bianco + driver incluso Câble blanc + transformateur inclus		Length: 3 m Lunghezza: 3 m Longueur: 3 m
	Light temperature: Temperatura luce: Température de la lumière:	Extra warm white led light 2700K Luce calda led bianco extra 2700K Lumière chaude LED blanc extra 2700K		
	Accessory on request: Accessorio su richiesta: Accessoire sur demande:	Dimmer Led Kit Dimmer Led Kit Dimmer Led Kit	On request: Su richiesta: Sur demande:	Dali driver
COLOURS COLORI COULEURS	SPECIAL LIGHTING COLOURS (MATT FINISH)			
	 GREY VEININGS			
	MATT LACQUERED (METAL)  ABSOLUTE WHITE (white RAL 9016 matching)			
NOTES NOTE NOTES				







LIGHTING LED / LED LUMINOSO / LUMINEUSE LED

3000K

CODE CODICE CODE	LP SSW120			
TECHNICAL INFO INFO TECNICHE INFOS TECHNIQUES	Lithing system: Sistema di illuminazione: Système d'éclairage:	Flexible led tube Tubo flessibile led Tube led	15W LED system	Included Incluso Inclus
	Wiring: Cablaggio: Câblage:	White cable + driver included Cavo bianco + driver incluso Câble blanc + transformateur inclus		Length: 3 m Lunghezza: 3 m Longueur: 3 m
	Light temperature: Temperatura luce: Température de la lumière:	Warm white led light 3000K Luce calda led bianco 3000K Lumière chaude LED blanc 3000K		
	Accessory on request: Accessorio su richiesta: Accessoire sur demande:	Dimmer Led Kit Dimmer Led Kit Dimmer Led Kit	On request: Su richiesta: Sur demande:	Dali driver
COLOURS COLORI COULEURS	SPECIAL LIGHTING COLOURS (MATT FINISH)			
	 GREY VEININGS			
	MATT LACQUERED (METAL)  ABSOLUTE WHITE (white RAL 9016 matching)			
NOTES NOTE NOTES				

LIGHTING LED / LED LUMINOSO / LUMINEUSE LED

4000K



CODE CODICE CODE	LP SSW121	    		
TECHNICAL INFO INFO TECNICHE INFOS TECHNIQUES	Lithing system: Sistema di illuminazione: Système d'éclairage:	Flexible led tube Tubo flessibile led Tube led	15W LED system	Included Incluso Inclus
	Wiring: Cablaggio: Câblage:	White cable + driver included Cavo bianco + driver incluso Câble blanc + transformateur inclus		Length: 3 m Lunghezza: 3 m Longueur: 3 m
	Light temperature: Temperatura luce: Température de la lumière:	Cool white led light 4000K Luce fredda led bianco 4000K Lumière froide LED blanc 4000K		
	Accessory on request: Accessorio su richiesta: Accessoire sur demande:	Dimmer Led Kit Dimmer Led Kit Dimmer Led Kit	On request: Su richiesta: Sur demande:	Dali driver
COLOURS COLORI COULEURS	SPECIAL LIGHTING COLOURS (MATT FINISH)			
	 <p>GREY VEININGS</p>			
NOTES NOTE NOTES	MATT LACQUERED (METAL)			
	 <p>ABSOLUTE WHITE (white RAL 9016 matching)</p>			

COMPONENTS / COMPONENTI / COMPOSANTS

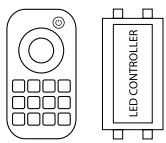





DIMMER LED KIT























Dimming remote control and LED controller

CODE CODICE CODE	LP DIM001 (LED controller)			
TECHNICAL INFO INFO TECNICHE INFOS TECHNIQUES	Dimensions: Dimensioni: Dimensions:	10 x 3 h 2 cm	Weight: Peso: Poids:	0,1 Kg
NOTES NOTE NOTES	LED controller (for nr.1 lamp). Remote control required. LED controller (per nr.1 lampada). Telecomando richiesto. LED controller (pour lampe nr.1). Télécommande requise.			
CODE CODICE CODE	LP DIM002 (remote control)			
TECHNICAL INFO INFO TECNICHE INFOS TECHNIQUES	Dimensions: Dimensioni: Dimensions:	12 x 5 h 2 cm	Weight: Peso: Poids:	0,1 Kg
NOTES NOTE NOTES	RF dimming remote controller, wireless remote 30m distance (for one or more lamps). Telecomando dimmerabile RF, telecomando wireless a 30 m di distanza (per una o più lampade). Télécommande à gradation RF, distance sans fil de 30 m (pour une ou plusieurs lampes). Inserted into the Giotto box if purchased at the same time. Inserito nella scatola Giotto se acquistato contemporaneamente. Inséré dans le carton Giotto si acheté en même temps.			

SYMBOLS

	Product for indoor use only. Prodotto per uso interno. Produit à usage interne.	
	Product for indoor and outdoor use. Prodotto per uso interno ed esterno. Produit à usage interne et externe.	
	Fireproof product. Prodotto ignifugo. Produit ignifuge.	
	Stackable product. Prodotto impilabile. Produit empilable.	
	Conformity to the European Community instructions. Conformità alle istruzioni della Comunità Europea. Conformité aux instructions de la Communauté Européenne.	

LIGHTING SYMBOLS

	Lighting system compatible with LED light bulbs. Sistema di illuminazione compatibile con lampadine LED. Système d'éclairage compatible avec des ampoules LED.	
	LED lighting system. Sistema di illuminazione a LED. Système d'éclairage LED.	
	LED tube lighting system. Sistema di illuminazione per tubo LED. Système d'éclairage pour tube LED.	
	Product compatible with Candy Light module. Prodotto compatibile con modulo Candy Light. Produit compatible avec le module Candy Light.	
	Dimmable item. Prodotto dimmerabile. Article dimmable.	
	Product with base model I1. Prodotto con base I1. Produit avec embase I1.	
	Product with base model E1. Prodotto con base E1. Produit avec embase E1.	
	Protected against the intrusion of solid objects $\varnothing > 12$ mm, not against water. Protetto contro l'intrusione di corpi solidi $\varnothing > 12$ mm, non contro l'acqua. Protégé contre l'intrusion de corps solides $\varnothing > 12$ mm, pas contre l'eau.	
	Protected against the intrusion of dust and water jets. Protetto contro l'intrusione di polvere e getti d'acqua. Protégé contre l'intrusion de poussières et de jets d'eau.	
	Fully protected against the intrusion of dust and immersion in water. Completamente protetto contro l'intrusione di polvere e l'immersione in acqua. Entièrement protégé contre l'intrusion de poussière et l'immersion dans l'eau.	
	Insulation class 1. Classe di isolamento 1. Classe d'isolation 1.	
	Insulation class 2. Classe di isolamento 2. Classe d'isolation 2.	
	Insulation class 3. Classe di isolamento 3. Classe d'isolation 3.	
	Device proper to direct assembly onto normally inflammable surfaces. Dispositivo adatto al montaggio diretto su superfici normalmente infiammabili. Dispositif propre à diriger le montage sur des surfaces normalement inflammables.	
	On request, the photometric data of the product are available in EULUMDAT standard or a similar one. Su richiesta, sono disponibili i dati fotometrici del prodotto nello standard EULUMDAT o similari. Sur demande, les données photométriques du produit dans la norme EULUMDAT ou similaire sont disponibles.	



EN - Warning: the appropriate use of these instructions ensures the good maintenance of the product. Always consult the technical sheet of the product on the www.slidedesign.it website.

- Before any operation on the fixture, please disconnect the power supply.
- Assembly and maintenance of the fixture must be performed carefully so components are not damaged.
- Replacement bulbs must be the same type and wattage as specified in the technical sheet. Use LED bulbs only.
- In case of damage to the feeding cable, please contact a SLIDE dealer or qualified personnel for replacement.
- Keep away from excessive heat sources.
- Avoid any improper use. Do not stand on the products. When the product has to be moved, lift the product off the ground in order to avoid damages.
- Always protect the product with its original packaging when not in use for a long time.



IT - Attenzione: l'uso appropriato delle seguenti istruzioni garantisce il buon mantenimento del prodotto, pertanto è necessario conservarle. Consultare la scheda tecnica del prodotto sul sito www.slidedesign.it.

- Prima di ogni operazione sull'apparecchio, disinserire la tensione di rete.
- Le operazioni di montaggio o manutenzione devono essere eseguite con la massima attenzione per non danneggiare i componenti.
- L'eventuale sostituzione della lampadina deve essere fatta con una dello stesso tipo e potenza massima indicata nella scheda tecnica. Si raccomanda l'uso esclusivo di lampadine a basso consumo energetico.
- In caso di danneggiamento del cavo di alimentazione, per la sostituzione contattare un rivenditore SLIDE o personale qualificato.
- Evitare di posizionare il prodotto in prossimità di fonti di calore eccessive.
- Evitare usi impropri e non consoni del prodotto. Non salire con i piedi sul prodotto. In caso di spostamento, sollevare il prodotto onde evitare danni ai componenti che appoggiano a terra.
- Proteggere sempre il prodotto con il suo imballo originale quando inutilizzato per lungo tempo.



FR - Attention: l'entretien correct du produit est garanti par l'application appropriée de ces instructions. Il est donc nécessaire de les garder. Toujours consulter la fiche technique du produit sur le site www.slidedesign.it.

- Avant toute opération sur l'appareil déconnecter l'alimentation électrique.
- Le montage et les manipulations de l'appareil devront être exécutés avec la plus grande attention pour ne pas abîmer ses composants.
- Tout changement d'ampoule respectera le type et la puissance indiqués dans la fiche technique. Il est recommandé de n'utiliser que des ampoules à basse consommation d'énergie.
- En cas d'endommagement du câble d'alimentation, et en vue de son remplacement, contactez votre revendeur SLIDE ou une personne dûment habilitée.
- Éviter de placer le produit à proximité de sources de chaleur excessive.
- Éviter l'utilisation inappropriée du produit. Ne pas monter sur les produits. Lorsque le produit doit être déplacé, soulever le produit afin d'éviter tout dommage.
- Toujours protéger le produit avec son emballage d'origine lorsqu'il n'est pas utilisé.

WARRANTY | GARANZIA | GARANTIE

EN - SLIDE products are guaranteed against all manufacturing faults, granted that the items are appropriately used, for twenty-four (24) months from the date of purchase upon presentation of the invoice.

LEDs are guaranteed for twelve (12) months from the date of purchase.

Warranty doesn't include parts that are subject to wear and tear due to usage, batteries when provided, wiring and electrical parts that do not have manufacturing faults.

SLIDE declines any liability to damages caused to things or persons by an illegitimate use of the product.

SLIDE won't accept any returned goods without having checked the kind of defects first.

IT - I prodotti SLIDE sono garantiti per difetti di fabbricazione in condizioni normali d'uso del prodotto, per un periodo di ventiquattro (24) mesi dalla data di acquisto, comprovata da documento d'acquisto.

Per i sistemi di illuminazione LED la garanzia è di dodici (12) mesi dalla data di acquisto.

Sono escluse dalla garanzia le parti soggette ad usura in seguito all'utilizzo, le batterie quando fornite in dotazione, cavi e componenti elettrici, che non presentino difetti di fabbricazione.

SLIDE declina ogni responsabilità per danni causati a cose o persone da un uso non corretto del prodotto.

SLIDE non accetterà nessun reso se non dopo aver accertato la natura del difetto.

FR - Les produits SLIDE sont garantis contre les vices de fabrication dans des conditions d'utilisation normales, pour une période de vingt-quatre (24) mois à compter de la date d'achat, avec la preuve d'achat.

Pour les systèmes d'éclairage LED la garantie est de douze (12) mois à compter de la date d'achat.

La garantie ne couvre pas les pièces d'usure après utilisation, les piles si fournis, et câbles et composants électriques qui n'ont pas de défauts de fabrication.

SLIDE décline toute responsabilité pour les dommages causés aux personnes ou aux biens dus à une utilisation inappropriée du produit. SLIDE ne remplacera aucun appareil sans avoir pu en constater le défaut.

MAINTENANCE & CLEANING | MANUTENZIONE & PULIZIA | MAINTENANCE & NETTOYAGE

EN - Check the material composition of the product on the technical sheet on www.slidedesign.it.

- To prevent dust and dirt from sticking to the plastic surfaces, periodically clean the products.
- Avoid using ethanol or any liquids containing acetone, trichloroethylene or ammonia (solvents in general).
- **POLYETHYLENE:** clean the product with a damp cloth and neutral liquid soap diluted in water.
It is recommended the use of SLIDE's "CleanUp" cleaner or a degreaser. In case of persistent stains, use a scrub eraser (melamine foam - Scotch-Brite Easy Eraser or similar) or a hot water pressure washer.
Spray the cleaning product on the surface, rub with a damp cloth and rinse abundantly with hot water.
- **POLYURETHANE:** clean the products with a soft cloth and neutral liquid soap diluted in water, especially if the surface comes into contact with highly coloured substances (such as coffee, tea, oil, etc.).
- **POLYPROPYLENE:** clean the products with a damp cloth and neutral liquid soap diluted in water and degreaser.
Rinse with plenty of water.
- Lacquered version: periodically clean with a polish cleaner, gently rubbing with soft cloth/cotton wool.
- Fabrics can be cleaned with a damp cloth, neutral liquid soap and water.
- For metal parts use specific cleaners.
- For **HPL**, clean the surface with a damp cloth and neutral liquid soap diluted in water.

IT - Verificare il materiale di composizione del prodotto sulla scheda tecnica sul sito www.slidedesign.it.

- Evitare accumuli di polvere o di sporco sulle superfici e pulire periodicamente il prodotto.
- Evitare l'uso di alcool e di detersivi contenenti acetone, trielina e ammoniaca (solventi in generale).
- **POLIETILENE:** pulire il prodotto con un panno umido e detersivo liquido neutro, diluito con acqua.
È consigliato l'utilizzo del pulitore "CleanUp" di SLIDE o di uno sgrassatore e, in caso di macchie persistenti, l'utilizzo di gomma cancella-macchie (schiuma di melamina: Scotch-Brite o simili) o idropulitrice ad acqua calda. Spruzzare lo sgrassatore sulla superficie da trattare e strofinare con un panno umido.
Risciacquare abbondantemente con acqua, preferibilmente con idropulitrice ad acqua calda.
- **POLIURETANO:** pulire il prodotto con un panno morbido, frizionando, soprattutto nel caso la superficie venga a contatto con sostanze particolarmente coloranti (es. caffè, tè, olio, ecc). Utilizzare solo prodotti neutri in soluzione acquosa.
- **POLIPROPILENE:** pulire con un panno umido e acqua con detersivo sgrassante. Risciacquare abbondantemente con acqua.
- Per la versione laccata: pulire periodicamente con una pasta tipo "polish" o cera auto, strofinando delicatamente con ovatta.
- Per la pulizia dei tessuti utilizzare un panno umido con sapone neutro e acqua.
- Per le parti metalliche utilizzare prodotti specifici evitando l'uso di polveri abrasive e pagliette.
- Per l'**HPL**, pulire il prodotto con un panno umido e detersivo liquido neutro, diluito con acqua.

FR - Vérifier la composition des matériaux du produit sur la fiche technique sur www.slidedesign.it.

- Eviter l'accumulation de poussière et de saleté sur la surface et nettoyer régulièrement le produit.
- Eviter d'utiliser alcool et détergents contenant de l'acétone, du trichloréthylène et de l'ammoniac (solvants en général).
- **POLYETHYLENE:** nettoyer le produit avec un chiffon humide et un détergent liquide neutre dilué avec de l'eau.
Il est recommandé d'utiliser le détergent "CleanUp" de SLIDE ou un dégraissant et, en cas de taches persistantes, d'utiliser une éponge grattante (mousse de mélamine: Scotch-Brite ou similaire) ou nettoyeur haute pression d'eau chaude.
Vaporiser le produit sur la surface, frotter avec un chiffon humide et rincer abondamment avec de l'eau.
- **POLYURETHANE:** nettoyer le produit avec un chiffon, en frottant, surtout si la surface est entrée en contact avec des substances particulièrement colorantes. N'utiliser que des produits neutres en solution aqueuse.
- **POLYPROPYLENE:** nettoyer avec un chiffon humide et de l'eau avec un détergent dégraissant.
Rincer abondamment avec de l'eau.
- Version laquée: utiliser périodiquement une pâte de type "polish" ou de la cire, en frottant doucement avec un chiffon.
- Pour nettoyer les tissus utiliser un chiffon humide avec un savon doux et de l'eau.
- Pour les parties métalliques, utiliser des produits spécifiques.
- Pour l'**HPL**, nettoyer la surface avec un chiffon humide et un détergent liquide neutre dilué avec de l'eau.



Product made with 100% recyclable material.
Prodotto in materiale riciclabile al 100%.
Produit réalisé en matériel 100% recyclable.



Certifies the conformity of the product to the European Community instructions.
Certifica la conformità del prodotto alle disposizioni delle direttive comunitarie.
Atteste la conformité du produit aux dispositions des directives communautaires.



Appliance suitable for installation on normally inflammable surfaces.
Apparecchio idoneo ad essere installato su superfici normalmente infiammabili.
L'appareil peut être installé sur des surfaces normalement inflammables.



Recycling and disposal of electronic waste (WEEE).
Questo prodotto richiede uno smaltimento differenziato (RAEE).
Ce produit nécessite un tri sélectif (DEEE).