

Ibis 002

IBIS COLLECTION:

Ibis 002, Ibis 160, Ibis 160-G, Ibis 139,
Ibis 302, Ibis 302B, Ibis 303, Ibis 303B,
Ibis 002-DP, Ibis 002-DR,

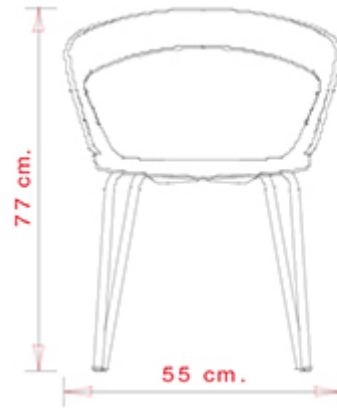

Armchair with 4 legs steel frame and techno-polymer shell.

STACKABLE

4

WEIGHT

4,7 kg

PACK

0,39 m³

PIECES PER BOX

4

FINISHES SEATING

PP POLYPROPYLENE

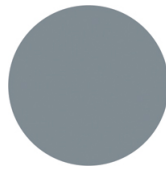
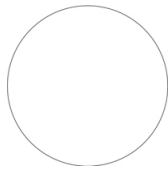

NCS S0502-B
Traffic white
(Available while stocks last)



NCS S7502-B
Anthracite grey
(Available while stocks last)



NCS S4005-Y20R
Turtle-dove
(Available while stocks last)



NCS S4005-B20G
Squirrel grey
(available while stocks last)



NOTE

Resources

3ds



| dwg



FRAMES

AC STEEL



CR Chrome



NCS S4000-N VR White aluminium



NCS S9000-N VR Jet black

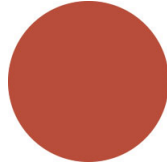

NCS S3060-Y80R Coral red



VR Rough metallic bronze



NCS S9000-N VR Matt Jet Black

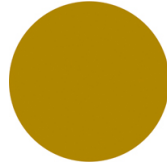

NCS S3060-Y Curry



NCS S7020-G50Y Olive green



NCS S4050-B40G Water blue

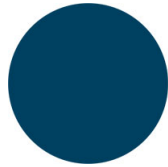

NCS S6030-B Capri blue

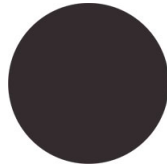

NCS S8005-Y20R Brown



NCS s0502-b VR Traffic white

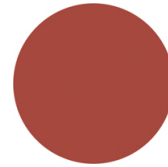

NCS S4040-R Marsala



VR Pewter



NCS S7502-B VR Anthracite grey



NCS S0500-N VR Pure white



CERTIFICATIONS

- > UNI/EN 1022:1998 - Stabilità (14/04/04)
- > UNI/EN 15373 - Test 1. Carico statico sedile e schienale: 5 (14/04/04)
- > UNI/EN 15373 - Test 10. Prova di fatica sedile e schienale: 5 (14/04/04)
- > UNI/EN 15373 - Test 13. Resistenza a fatica dei braccioli: 5 (14/04/04)
- > UNI/EN 15373 - Test 16. Carico statico sulle gambe anteriori: 5 (14/04/04)
- > UNI/EN 15373 - Test 6. Carico statico orizzontale sui braccioli: 5 (14/04/04)

USES

coffee & restaurants, hotels, educational, entertainment, travel, office and waiting areas, retail, health care,

Ibis 160

IBIS COLLECTION:

Ibis 002, Ibis 160, Ibis 160-G, Ibis 139,
Ibis 302, Ibis 302B, Ibis 303, Ibis 303B,
Ibis 002-DP, Ibis 002-DR,



Armchair with steel sled frame and techno-polymer shell.

STACKABLE

4

WEIGHT

6,9 kg

PACK

0,39 m³

PIECES PER BOX

4

FINISHES SEATING

PP POLYPROPYLENE

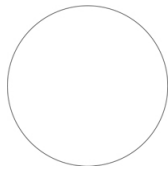

NCS S0502-B
Traffic white
(Available while stocks last)



NCS S7502-B
Anthracite grey
(Available while stocks last)



NCS S4005-Y20R
Turtle-dove
(Available while stocks last)



NCS S4005-B20G
Squirrel grey
(available while stocks last)



NOTE

Resources

[3ds](#)



| [dwg](#)



FRAMES

AC STEEL



CR Chrome



NCS S4000-N VR White
aluminium



NCS S9000-N VR Jet
black

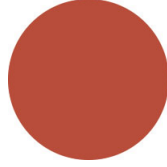

NCS S3060-Y80R
Coral red



VR Rough metallic
bronze



NCS S9000-N VR
Matt Jet Black

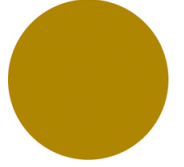

NCS S3060-Y Curry



NCS S7020-G50Y
Olive green



NCS S4050-B40G
Water blue

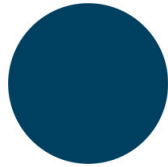

NCS S6030-B
Capri blue

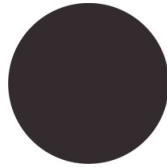

NCS S8005-Y20R
Brown



NCS s0502-b VR
Traffic white

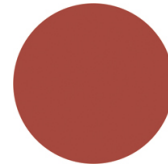

NCS S4040-R
Marsala

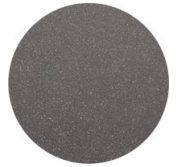

VR Pewter



NCS S7502-B VR
Anthracite grey



NCS S0500-N VR Pure
white



USES

coffee & restaurants, hotels, educational, entertainment, travel, office and waiting areas, retail, health care,

Ibis 160-G



IBIS COLLECTION:

Ibis 002, Ibis 160, Ibis 160-G, Ibis 139,
Ibis 302, Ibis 302B, Ibis 303, Ibis 303B,
Ibis 002-DP, Ibis 002-DR,



Armchair with steel sled frame and linking device.
Techno-polymer shell.

STACKABLE

4

WEIGHT

7,5 Kg

PACK0,39 m³**PIECES PER BOX**

4

FINISHES SEATING

PP POLYPROPYLENE

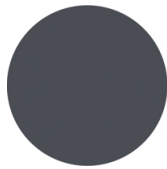
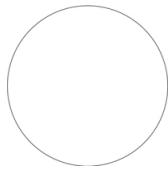

NCS S0502-B
Traffic white
(Available while stocks last)

NCS S7502-B
Anthracite grey
(Available while stocks last)

NCS S4005-Y20R
Turtle-dove
(Available while stocks last)

NCS S4005-B20G
Squirrel grey
(available while stocks last)



NOTE

Resources

3ds



| dwg



FRAMES

AC STEEL



CR Chrome



NCS S4000-N VR White aluminium



NCS S9000-N VR Jet black

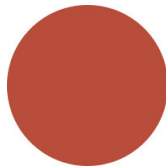

NCS S3060-Y80R Coral red



VR Rough metallic bronze



NCS S9000-N VR Matt Jet Black

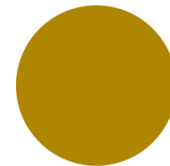

NCS S3060-Y Curry



NCS S7020-G50Y Olive green



NCS S4050-B40G Water blue

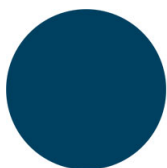

NCS S6030-B Capri blue

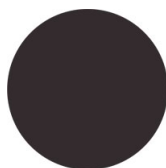

NCS S8005-Y20R Brown



NCS s0502-b VR Traffic white

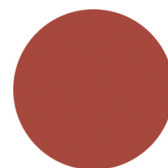

NCS S4040-R Marsala

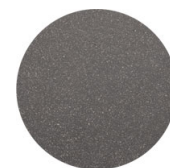

VR Pewter



NCS S7502-B VR Anthracite grey



NCS S0500-N VR Pure white

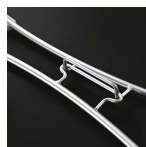

LINKING DEVICE

USES

coffee & restaurants, hotels, educational, entertainment, travel, office and waiting areas, retail, health care,

Ibis 139

IBIS COLLECTION:

Ibis 002, Ibis 160, Ibis 160-G, Ibis 139, Ibis 302, Ibis 302B, Ibis 303, Ibis 303B, Ibis 002-DP, Ibis 002-DR,

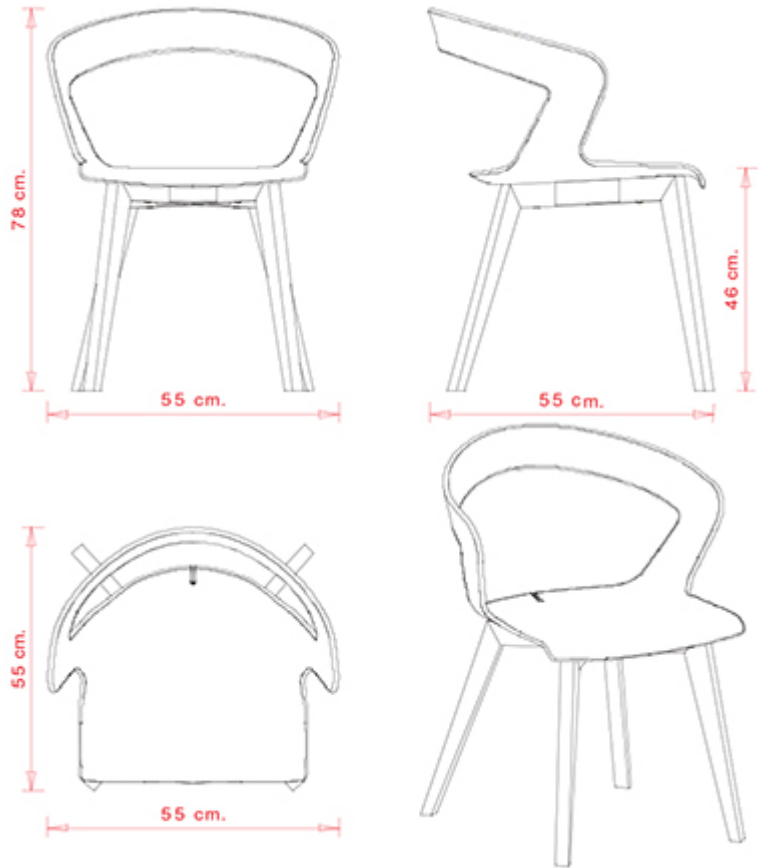

Armchair with 4 legs, beech wood frame. Techno-polymer shell.

WEIGHT

6 kg

PACK

0,34 m³

PIECES PER BOX

1

FINISHES SEATING

PP POLYPROPYLENE

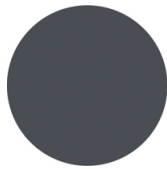
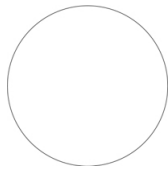

NCS S0502-B
Traffic white
(Available while stocks last)



NCS S7502-B
Anthracite grey
(Available while stocks last)



NCS S4005-Y20R
Turtle-dove
(Available while stocks last)



NCS S4005-B20G
Squirrel grey
(available while stocks last)



NOTE

Resources

3ds



| dwg



FRAMES

LE WOOD

Beech | Honey stained



Beech | Chesnut stained



Beech | Grey stained

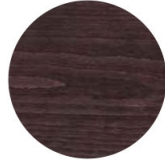

Beech | Dark brown stained

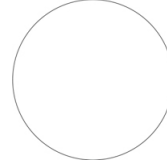
Beech | Stained according to
sample

beech | Black stained

CERTIFICATIONS

- > ANSI/BIFMA X5.1-2011 - Par.11. Prove di fatica sulla seduta (20/08/16)
- > ANSI/BIFMA X5.1-2011 - Par.12. Stabilità (20/08/16)
- > ANSI/BIFMA X5.1-2011 - Par.16. Prove di fatica sullo schienale (05/09/16)
- > ANSI/BIFMA X5.1-2011 - Par.18. Sforzo statico sulla gambe (19/09/16)
- > ANSI/BIFMA X5.1-2011 - Par.6. Sforzo statico sullo schienale (06/07/16)
- > ANSI/BIFMA X5.1-2011 - Par.8. Caduta di un peso (12/07/16)
- > UNI/EN 16139:2013 - Prova 12. Carico statico gambe anteriori: 2-Usò estremo (07/06/13)
- > UNI/EN 16139:2013 - Prova 13. Carico statico gambe laterali: 2-Usò estremo (07/06/13)

USES

coffee & restaurants, hotels, educational, entertainment, travel, office and waiting areas, retail, health care,

Ibis 302

IBIS COLLECTION:

Ibis 002, Ibis 160, Ibis 160-G, Ibis 139, Ibis 302, Ibis 302B, Ibis 303, Ibis 303B, Ibis 002-DP, Ibis 002-DR,

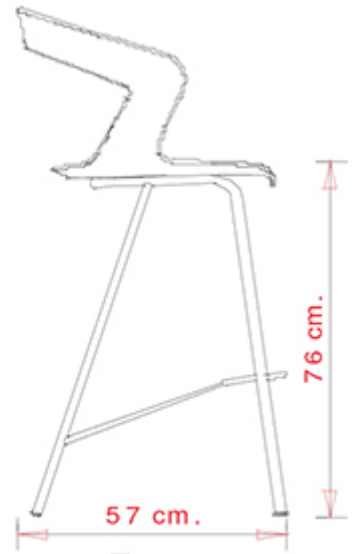
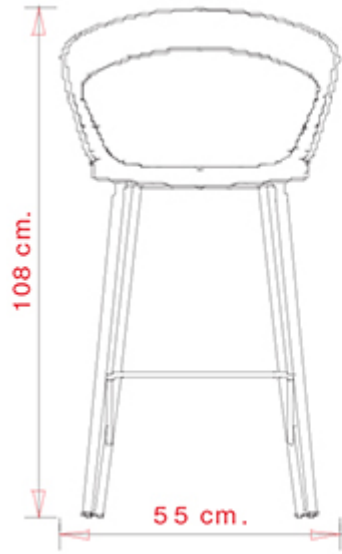

Barstool with 4 legs steel frame and techno-polymer shell.

WEIGHT

6,2 kg

PACK

0,35 m³

PIECES PER BOX

1

FINISHES SEATING

PP POLYPROPYLENE

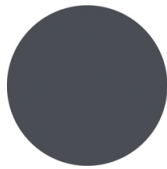
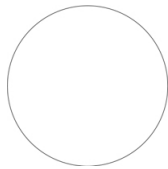

NCS S0502-B
Traffic white
(Available while stocks last)



NCS S7502-B
Anthracite grey
(Available while stocks last)



NCS S4005-Y20R
Turtle-dove
(Available while stocks last)



NCS S4005-B20G
Squirrel grey
(available while stocks last)



NOTE

Resources

3ds



| dwg



FRAMES

AC STEEL



CR Chrome



NCS S4000-N VR White aluminium



NCS S9000-N VR Jet black

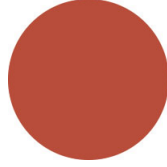

NCS S3060-Y80R Coral red



VR Rough metallic bronze



NCS S9000-N VR Matt Jet Black

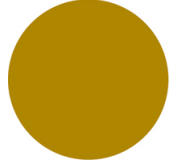

NCS S3060-Y Curry



NCS S7020-G50Y Olive green



NCS S4050-B40G Water blue

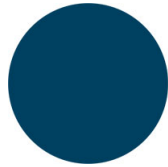

NCS S6030-B Capri blue

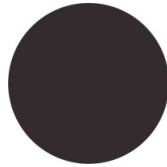

NCS S8005-Y20R Brown



NCS s0502-b VR Traffic white

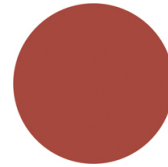

NCS S4040-R Marsala



VR Pewter



NCS S7502-B VR Anthracite grey



NCS S0500-N VR Pure white



USES

coffee & restaurants, hotels, educational, entertainment, travel, office and waiting areas, retail, health care,

Ibis 302B

IBIS COLLECTION:

Ibis 002, Ibis 160, Ibis 160-G, Ibis 139, Ibis 302, Ibis 302B, Ibis 303, Ibis 303B, Ibis 002-DP, Ibis 002-DR,



Barstool with 4 legs steel frame and techno-polymer shell. Seat height H 65 cm.

WEIGHT

5,9 Kg

PACK0,35 m³**PIECES PER BOX**

1

FINISHES SEATING

PP POLYPROPYLENE

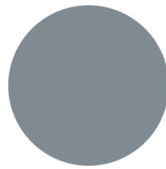
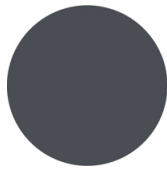
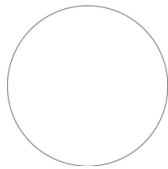

NCS S0502-B
Traffic white
(Available while stocks last)



NCS S7502-B
Anthracite grey
(Available while stocks last)



NCS S4005-Y20R
Turtle-dove
(Available while stocks last)



NCS S4005-B20G
Squirrel grey
(available while stocks last)



NOTE

Resources

3ds



| dwg



FRAMES

AC STEEL



CR Chrome



NCS S4000-N VR White
aluminium



NCS S9000-N VR Jet
black

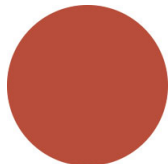

NCS S3060-Y80R
Coral red



VR Rough metallic
bronze



NCS S9000-N VR
Matt Jet Black

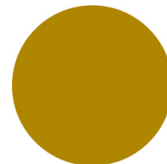

NCS S3060-Y Curry



NCS S7020-G50Y
Olive green



NCS S4050-B40G
Water blue

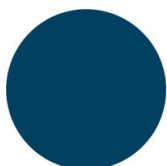

NCS S6030-B
Capri blue



NCS S8005-Y20R
Brown



NCS s0502-b VR
Traffic white

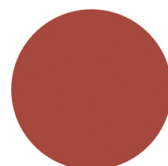

NCS S4040-R
Marsala

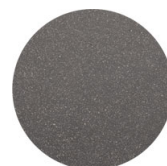

VR Pewter



NCS S7502-B VR
Anthracite grey



NCS S0500-N VR Pure
white



USES

coffee & restaurants, hotels, educational, entertainment, travel, office and waiting areas, retail, health care,

Ibis 303

IBIS COLLECTION:

Ibis 002, Ibis 160, Ibis 160-G, Ibis 139, Ibis 302, Ibis 302B, Ibis 303, Ibis 303B, Ibis 002-DP, Ibis 002-DR,

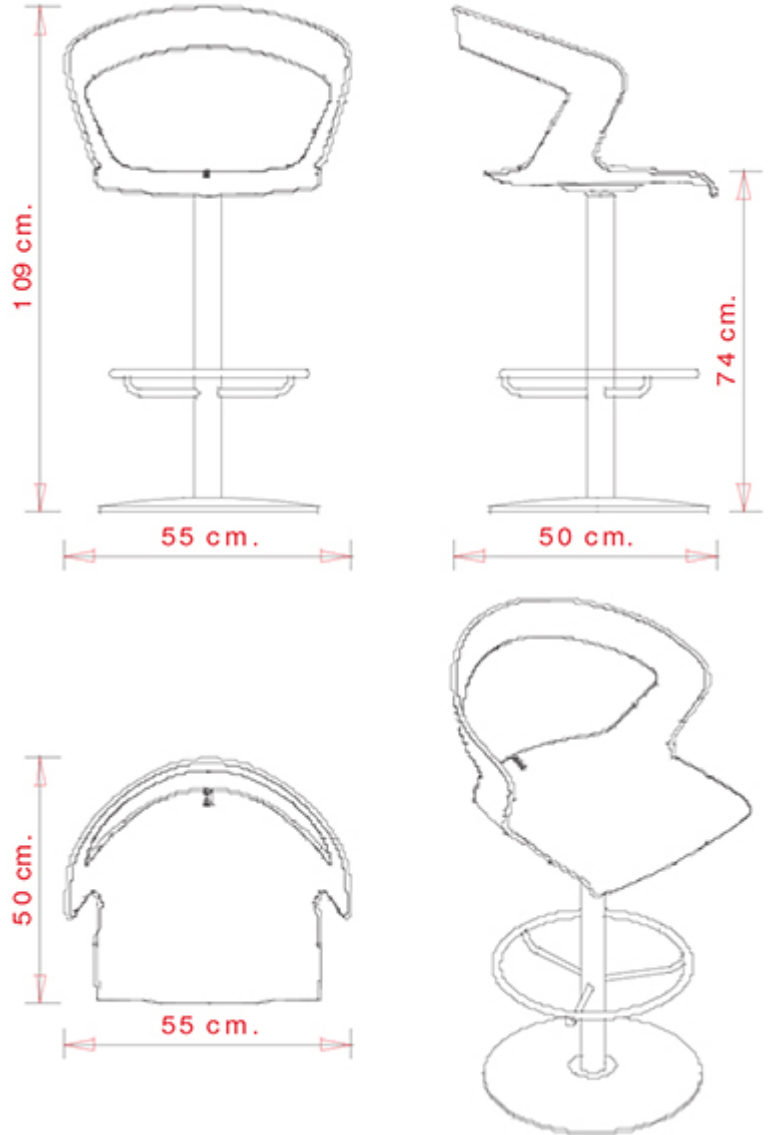

Swivel barstool with central steel base and techno-polymer shell.

WEIGHT

13,3 kg

PACK

0,35 m³

PIECES PER BOX

1

FINISHES SEATING

PP POLYPROPYLENE

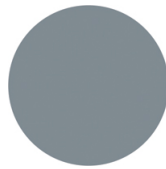
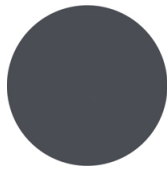
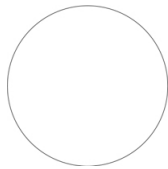

NCS S0502-B
Traffic white

NCS S7502-B
Anthracite grey

NCS S4005-Y20R
Turtle-dove

NCS S4005-B20G
Squirrel grey

(Available while stocks last)

(Available while stocks last)

(Available while stocks last)

(available while stocks last)



NOTE

Resources

3ds



| dwg



FRAMES

AC STEEL



CR Chrome



NCS S4000-N VR White
aluminium



NCS S9000-N VR Jet
black

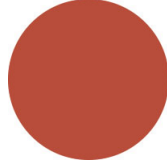

NCS S3060-Y80R
Coral red



VR Rough metallic
bronze



NCS S9000-N VR
Matt Jet Black

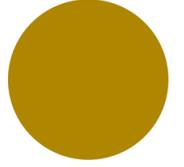

NCS S3060-Y Curry



NCS S7020-G50Y
Olive green



NCS S4050-B40G
Water blue

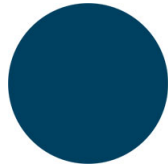

NCS S6030-B
Capri blue

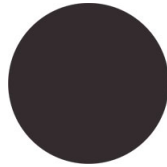

NCS S8005-Y20R
Brown



NCS s0502-b VR
Traffic white

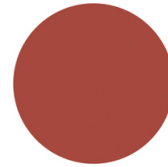

NCS S4040-R
Marsala



VR Pewter



NCS S7502-B VR
Anthracite grey



NCS S0500-N VR Pure
white



USES

coffee & restaurants, hotels, educational, entertainment, travel, office and waiting areas, retail, health care,

Ibis 303B

IBIS COLLECTION:

Ibis 002, Ibis 160, Ibis 160-G, Ibis 139, Ibis 302, Ibis 302B, Ibis 303, Ibis 303B, Ibis 002-DP, Ibis 002-DR,



Swivel barstool with central steel base and techno-polymer shell. Version seat-height H 65 cm.

WEIGHT

13 Kg

PACK0,35 m³**PIECES PER BOX**

1

FINISHES SEATING

PP POLYPROPYLENE

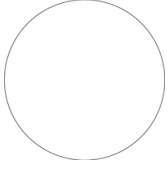

NCS S0502-B
Traffic white
(Available while stocks last) 

NCS S7502-B
Anthracite grey
(Available while stocks last) 

NCS S4005-Y20R
Turtle-dove
(Available while stocks last) 

NCS S4005-B20G
Squirrel grey
(available while stocks last) 

NOTE

Resources

[3ds](#)



| [dwg](#)



FRAMES

AC STEEL



CR Chrome



NCS S4000-N VR White aluminium



NCS S9000-N VR Jet black

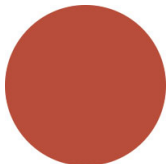

NCS S3060-Y80R Coral red



VR Rough metallic bronze



NCS S9000-N VR Matt Jet Black

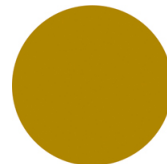

NCS S3060-Y Curry



NCS S7020-G50Y Olive green



NCS S4050-B40G Water blue

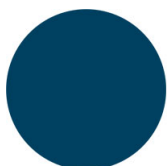

NCS S6030-B Capri blue



NCS S8005-Y20R Brown



NCS s0502-b VR Traffic white

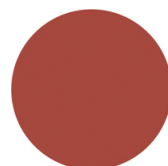

NCS S4040-R Marsala



VR Pewter



NCS S7502-B VR Anthracite grey



NCS S0500-N VR Pure white



USES

coffee & restaurants, hotels, educational, entertainment, travel, office and waiting areas, retail, health care,

Ibis 002-DP



IBIS COLLECTION:

Ibis 002, Ibis 160, Ibis 160-G, Ibis 139, Ibis 302, Ibis 302B, Ibis 303, Ibis 303B, Ibis 002-DP, Ibis 002-DR,



Swivel armchair with 5 ways aluminium frame. Techno-polymer shell.

WEIGHT

8,5 Kg

PACK

0,39 m³

PIECES PER BOX

1

FINISHES SEATING

PP POLYPROPYLENE

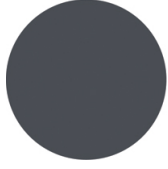
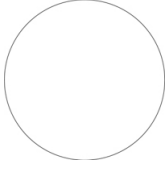

NCS S0502-B
Traffic white
(Available while stocks last) 

NCS S7502-B
Anthracite grey
(Available while stocks last) 

NCS S4005-Y20R
Turtle-dove
(Available while stocks last) 

NCS S4005-B20G
Squirrel grey
(available while stocks last) 

NOTE

Resources

[3ds](#)



| [dwg](#)



FRAMES

AL VR PAINTED ALUMINIUM



NCS S9000-N VR Jet black



AL PSH POLISHED ALUMINIUM



Polished aluminium

USES

coffee & restaurants, hotels, educational, entertainment, travel, office and waiting areas, retail, health care,

Ibis 002-DR



IBIS COLLECTION:

Ibis 002, Ibis 160, Ibis 160-G, Ibis 139, Ibis 302, Ibis 302B, Ibis 303, Ibis 303B, Ibis 002-DP, Ibis 002-DR,



Swivel armchair with 5 ways on castors, aluminium frame. Technopolymer shell.

WEIGHT

8,5 Kg

PACK0,39 m³**PIECES PER BOX**

1

FINISHES SEATING

PP POLYPROPYLENE

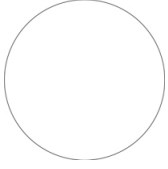

NCS S0502-B
Traffic white
(Available while stocks last)



NCS S7502-B
Anthracite grey
(Available while stocks last)



NCS S4005-Y20R
Turtle-dove
(Available while stocks last)



NCS S4005-B20G
Squirrel grey
(available while stocks last)



NOTE

Resources

3ds



| dwg



FRAMES

AL VR PAINTED ALUMINIUM



NCS S9000-N VR Jet black



AL PSH POLISHED ALUMINIUM



Polished aluminium

USES

coffee & restaurants, hotels, educational, entertainment, travel, office and waiting areas, retail, health care,